



# Electricity measurement Solution provider

High-precision current sensor | voltage sensor | electrical  
measuring instrument

**Shenzhen Hangzhi Precision Electronics Co., Ltd.**

Address: 330-342, Block B, Hua Yuan Technology Innovation Park, Baoyuan Road, Bao'an District, Shenzhen, P. R. China.

TEL:0755-82593440 Website: <https://www.hangzhiprecision.com/>

Email: [info@hangzhiprecision.com](mailto:info@hangzhiprecision.com)

Shenzhen Hangzhi Precision Electronics Co., Ltd

Innovative high-precision  
Popularization era of DC sensors

+

# CONTENTS

Company Introduction	02
Our History	03
Honors and Qualifications	05

**ABOUT HANGZHI**

01.

## 02 TECHNOLOGY R&D

R&D Capability	08
Quality Control	09
Sensor Technology	11

Current Sensor	14
Voltage Sensors	45
High Precision Testing Instruments	49

**HANGZHI PRODUCTS**

03.

# 01

## ABOUT HANGZHI



## COMPANY INTRODUCTION

Shenzhen Hangzhi Precision Electronics Co., Ltd. was founded in October 2017 as a high-tech enterprise dedicated to the R&D, production, sales, and solution customization of high-precision current, high-precision voltage, and high-precision electrical measuring instruments. Hangzhi's high-precision current sensor is a fluxgate-based current measurement and control component that senses current via classical control theory rather than conventional chip induction. Hangzhi focuses on developing a well-known brand of DC sensors, shattering foreign companies' market monopolies, and aspires to be a leading international enterprise in precision electronics in the field of DC systems.

### Investment and Financing

#### In December 2017

Hangzhi received Dongfang Fuhai Angel Round Financing

#### In March 2019

Hangzhi received Dongfang Fuhai PRE-A Round Financing

#### In March 2021

Hangzhi received Dongfang Jintai A Round Financing

# DEVELOPMENT HISTORY

2015

the high-precision DC sensor project was launched

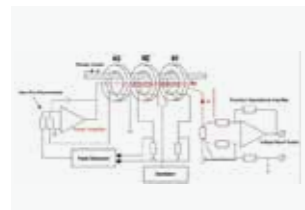

2017

the sample was successfully developed, and Shenzhen Hangzhi Precision Co., Ltd. was registered



2018

AIT series high-precision analog current sensor products were launched and received Angel investment from Dongfang Fuhai



2019

IIT series industrial control level current sensor products were launched/DIT series high-precision digital current sensor products were launched and received PRE-A investment from Dongfang Fuhai

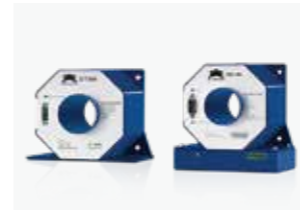

2020

20000A high current sensors were launched/HIU series high-precision AC/DC tester products were launched/PSM series AC/DC standard meter products were launched



2021

HIT series Hall replacement current sensor products were launched/RIT series residual current sensor products were launched



2022

2022: BMS series car current sensors were launched/HCV series voltage sensors were launched/PCB level current sensors were launched/low-cost measurement modules were launched/CIT series split core current sensors were launched, and received the A-round investment from Dongfang Jintai



# HONORS AND QUALIFICATIONS



The 6th China Innovation and Entrepreneurship Competition First Prize for Intelligent Hardware Group of Maker Competition



First Prize of Enterprise Group in the 6th Shenzhen Bao'an Innovation and Entrepreneurship Competition



IIT series CE-EMC and ROHS certification



AIT series CE-EMC and ROHS certification



HIT series CE-EMC and ROHS certification



IS9001: 2015 certification



National High-tech Enterprise



Second Prize of Enterprise Group in the Industry Final of the 11th China Shenzhen Innovation and Entrepreneurship Competition



Second Prize of the 9th Shenzhen Innovation and Entrepreneurship Competition Team Group Industry Final



First Prize of the 4th Shenzhen Bao'an Innovation and Entrepreneurship Competition Team Group



The 8th China Innovation and Entrepreneurship Competition Excellence Award of Growth Group for New Energy Industry Final



The 17th Shenzhen Enterprise Innovation (China) Record First Prize for Team Group of Competition



Advanced Manufacturing Industry Competition of Innovation Nanshan 2017 "Entrepreneurship Star" Competition



2019 Most Potential Entrepreneurship Project Award for "Shenzhen Innovation List"

# 02

## TECHNOLOGY R&D



## R&D CAPABILITY

### Master core technology

Dr. Tian Xinliang, the founder of Hangzhi Precision, and his core team have devoted 10 years to researching flux gate current sensor technology. They have been granted multiple core invention patents with independent intellectual property rights and have innovatively proposed applying a multi-point zero flux technology system to Hangzhi high-precision current sensors. By combining excitation flux closed-loop control technology, self-excited flux gate technology, and multiple closed-loop control technology, they have achieved the goal of zero flux closed-loop control of excitation flux, DC flux, and AC flux, and the detection of high-frequency ripple is realized by constructing a high-frequency ripple closed-loop channel, allowing the sensor to have relatively high gain and measurement accuracy within the full-bandwidth range.

### Technical team

The Hangzhi Precision R&D Center has a high-level and international R&D team. The core members of its technical team have decades of industry experience and extensive theoretical and practical experience. The team project has won multiple patents and received multiple project development funds and industrial application support from Shenzhen. Additionally, the center collaborates on technical talent exchange and R&D with renowned domestic research organizations and universities such as CASC, Shenzhen Institute of Metrology, South China University of Technology, and Harbin Institute of Technology.

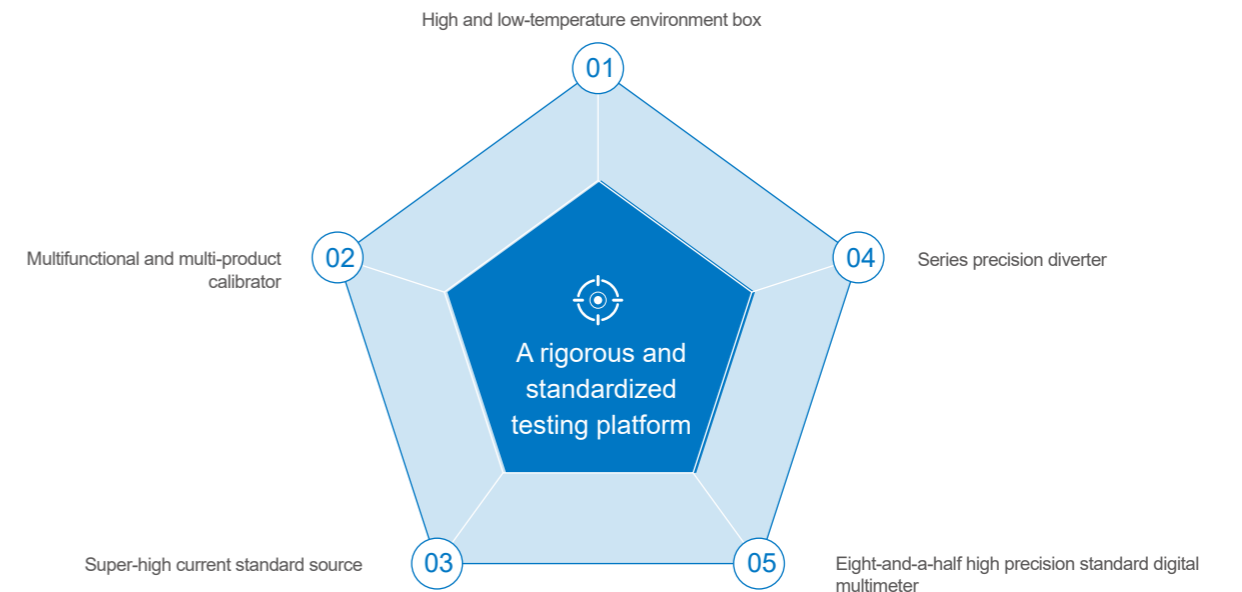



# QUALITY CONTROL

## Internal quality management process

Hangzhi has developed a functional department for quality management that is solely responsible for adhering to the closed-loop management and control process of quality control.

Supplier management (signing a Quality Agreement with all suppliers, requiring them to provide qualified products).

1. →Incoming inspection (corresponding quality sampling and inspection standards are performed, and any defects discovered will be dealt with immediately to prevent them from flowing into production.

2. →First article inspection (the first product produced will be inspected to ensure that it meets the requirements for operation, machine parameters, materials, operational standards, etc.).

3. →Process inspection (during the production process, the final products are inspected or tested on a regular basis to prevent anomalies.) → Testing and inspection (coils, PCB boards, and final products are 100% tested to prevent any non-conforming products from flowing out.) →Delivery inspection (product name, appearance, labeling, packaging, customer specifications, etc. are finally confirmed) →Supplier management

## Production management process

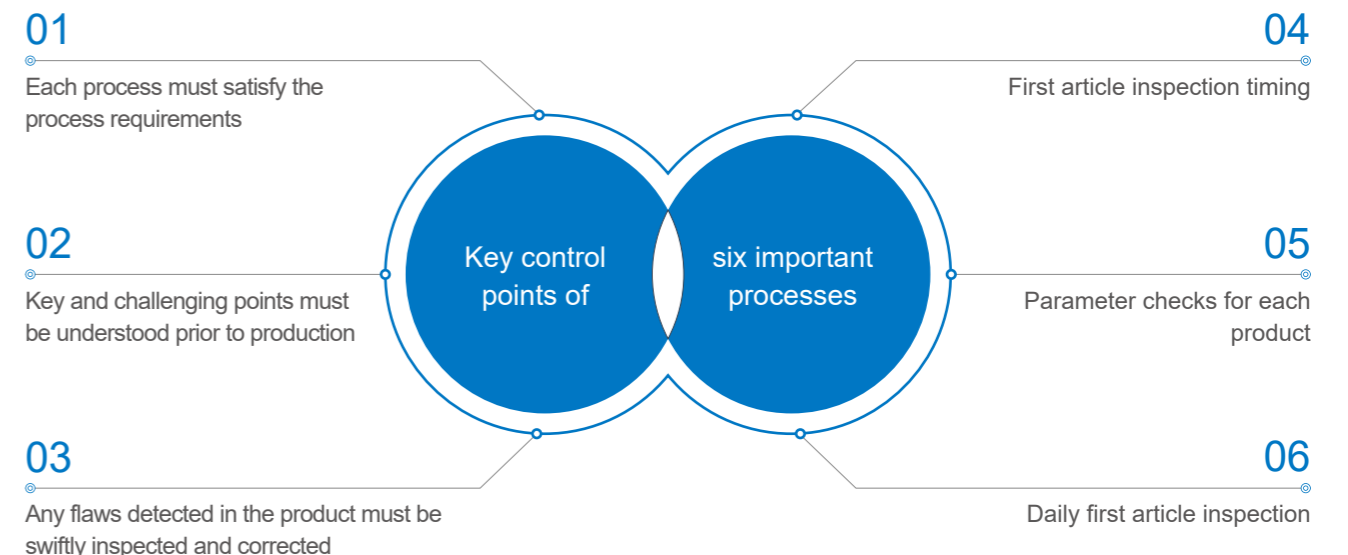
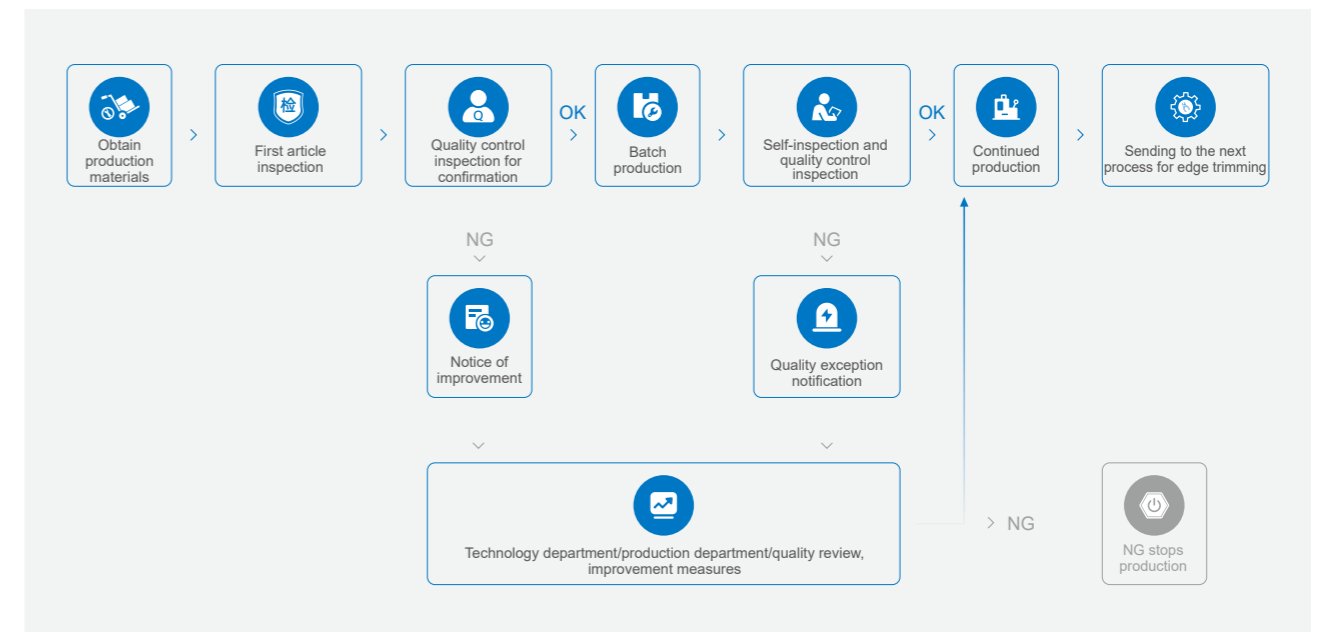

# SENSOR TECHNOLOGY

## Introduction to the fluxgate current sensor principle

Principle: under the saturation excitation of alternating magnetic fields, there is a nonlinear relationship between the magnetic induction intensity and magnetic field intensity of the high permeability magnetic core in the measured magnetic field, which the flux gate current sensor uses to measure weak magnetic fields. This physical phenomenon appears as a "gate" to the measured environmental magnetic field, modulating the corresponding magnetic flux and generating induced electromotive force. This phenomenon is used to indirectly estimate the current by measuring the magnetic field generated by the current. This physical phenomenon acts as a "gate" to the observed environmental magnetic field, modulating the related magnetic flux and generating induced electromotive force.

In magnetic circuits, current compensation must be provided to the secondary compensation coils in order to create an analogous zero flux magnetic field. The product of the compensation current and the number of turns of the compensation coils is directly proportional to the measured primary current, i.e.,  $I_p = N_s I_s 0$ . In addition, the excitation core and excitation coils form a saturation inductor. In the case of zero magnetic flux, the sensor magnetic circuit is detected based on a change in the sensor's inductance value.

Overall schematic of the fluxgate sensor

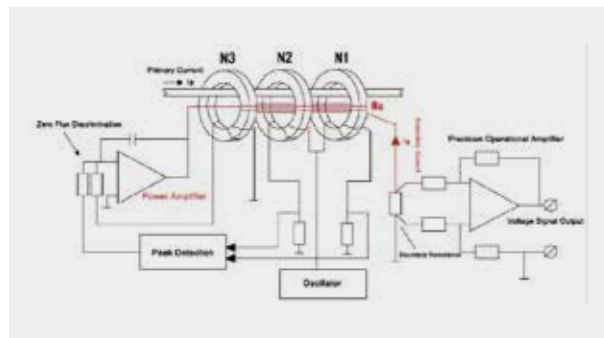

## Introduction to the Hall Current Sensor Principle

Hall current sensors include Open-loop Hall current sensors and closed-loop Hall current sensors.

Working principle of open-loop Hall current sensors

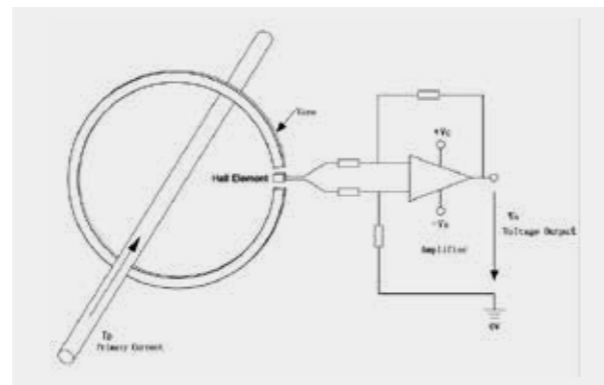

The open-loop Hall current sensor is made up of a magnetic core, a Hall element, and an amplification circuit, as illustrated in the figure. The magnetic core has an open-air gap, and the Hall element is placed in the air gap. The magnetic core has an open-air gap in which the Hall element is placed. When a current flows through a primary conductor, a magnetic field with a strength proportional to the magnitude of the current is formed around the conductor. The magnetic field lines are gathered by the magnetic core and directed to the air gap. The Hall element generates a voltage signal proportional to the intensity of magnetic induction at the air gap. The amplification circuit amplifies and outputs the signal. A voltage signal of roughly  $\pm 10V$ . Furthermore, in order to enhance electromagnetic compatibility, some sensors convert voltage signals into current signals for output.

Working principle of closed-loop Hall current sensor

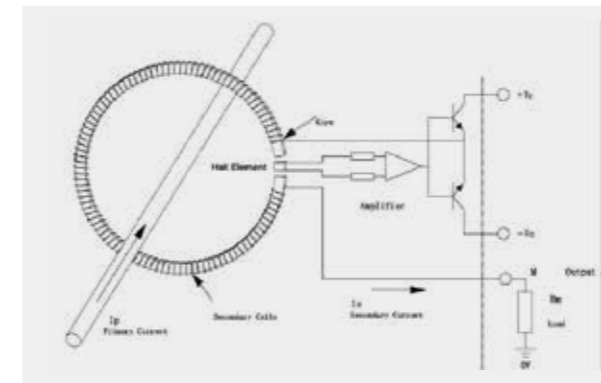

As illustrated in the figure, the closed-loop Hall current sensor consists of a magnetic core, a Hall element, an amplification circuit, and a secondary compensation winding. Compared to the open-loop Hall current sensor, the closed-loop Hall current sensor contains an additional secondary compensation winding, substantially improving its performance.

The amplification circuit accepts the Hall element's output and amplifies it to deliver a current signal to the secondary compensation winding. The secondary compensation winding in the magnetic core generates a magnetic field equal in size and opposite in direction to the magnetic field generated by the primary current at the air gap, offsetting the primary magnetic field and establishing a negative feedback closed-loop control circuit.

If the secondary current is too low, the magnetic field generated is insufficient to offset the primary magnetic field, and the amplifying circuit outputs a higher current. In contrast, the amplifying circuit's output current will drop, preserving the magnetic field balance at the air gap.

If the primary current changes and disrupts the magnetic field balance at the air gap, the negative feedback closed-loop control circuit will alter the secondary output circuit to restore the magnetic field balance.

On a macro level, the air gap will always maintain zero magnetic flux in order to preserve magnetic balance, which is also why zero magnetic flux transformers and magnetic balance Hall current sensors have those names.

## The following are the main differences between the fluxgate current sensor and the Hall current sensor:

The Hall current sensor detects current by sensing an external magnetic field through a Hall chip. The sensing chip is susceptible to external interference, resulting in considerable zero and temperature drift. In addition, it requires the opening and cutting of the magnetic core in order to measure current through changes in magnetic flux in the magnetic core's air gap. The presence of an open-air gap indicates that the Hall current sensors have intrinsic flaws in measurement accuracy and anti-interference capacity.

Rather than using conventional chip induction, the fluxgate current sensor detects current using classical control theory. The external environment does not affect it and has little or no temperature drift. Its magnetic core does not need to be opened or cut, and it has low magnetic resistance, high magnetic flux stability, high sensor detection accuracy, sensitivity, and fast response.



# 03

## PRODUCT INTRODUCTION



# INTRODUCTION TO CURRENT SENSORS

Hangzhi current sensor is a fluxgate-based current measurement and feedback component. It uses a multi-point zero flux technology system to the flux gate current sensor and combines the excitation flux closed-loop control technology, self-excited flux gate technology, and multiple closed-loop control technology to achieve zero flux closed-loop control of excitation flux, DC flux, and AC flux.

The high-frequency ripple closed-loop channel is detected by constructing a high-frequency ripple, achieving relatively high gain and measurement accuracy across the full bandwidth range. It boasts high precision, high bandwidth, full range, low temperature, and low zero drift, and is AC/DC compatible.



### HIGH PRECISION

10ppm/0.02%/0.05% optional



### LOW-TEMPERATURE DRIFT

good consistency, temperature impact 0.1 PPM/degree



### FULL RANGE

single product 1% -100% consistent accuracy



### SUITABLE FOR AC/DC

it can measure AC, DC, and pulse current



### ZERO DRIFT

2ppm



### INTELLIGENTIZATION

start with load, overload protection, self-recovery

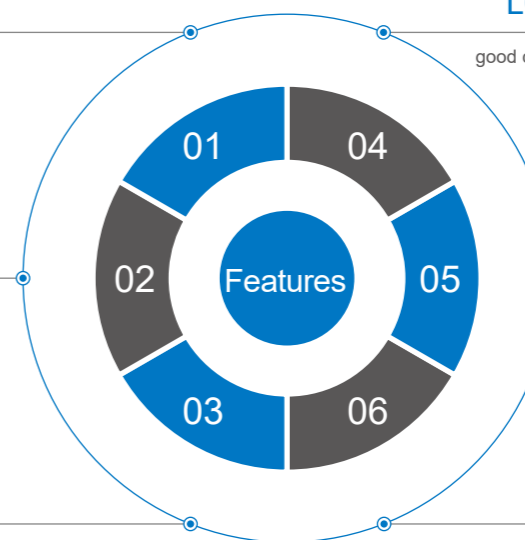

# High-precision Current Sensor

# AIT SERIES

## AIT60~AIT400

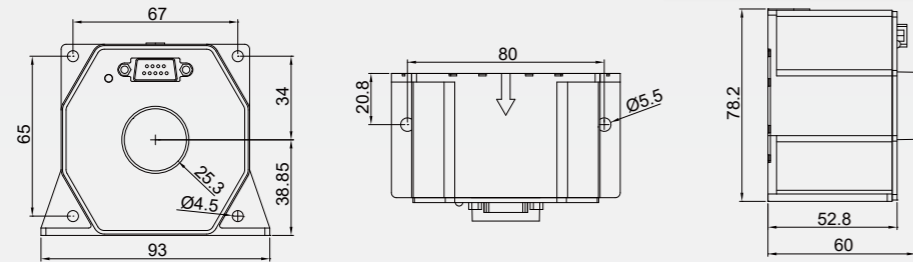

Product model	AIT60-SG	AIT100-SG	AIT200-SG	AIT300-SG	AIT400-SG
Primary rated DC current/ $I_{PN\_DC}$	±60A	±100A	±200A	±300A	±400A
Primary rated AC RMS/ $I_{PN}$	42A	70A	141A	212A	282A
Primary overload current/ $I_{PM}$	±72A	±120A	±240A	±360A	±480A
Supply voltage/ $V_C$	±15V	±15V	±15V	±15V	±15V
Standby power consumption current/ $I_{PWR}$	±30mA	±30mA	±30mA	±30mA	±30mA
Transformation ratio (primary: secondary)/ $K_N$	600:1	1000:1	1000:1	2000:1	2000:1
Rated output current/ $I_{SN}$	100mA	100mA	200mA	150mA	200mA
Accuracy/ $X_G$	10ppm	10ppm	10ppm	10ppm	10ppm
Linearity/ $\epsilon_L$	2ppm	2ppm	2ppm	2ppm	2ppm
Bandwidth/BW (3dB)	500kHz	500kHz	500kHz	500kHz	500kHz
Response time/ $t_r$	1μs	1μs	1μs	1μs	1μs
Current change rate/ $di/dt$	100A/μs	100A/μs	100A/μs	100A/μs	100A/μs
Zero offset current/ $I_{OT}$	±5μA	±5μA	±5μA	±5μA	±5μA
Operating temperature/ $T_A$	-40°C~85°C	-40°C~85°C	-40°C~85°C	-40°C~85°C	-40°C~85°C
Installation method	Disc installation	Disc installation	Disc installation	Disc installation	Disc installation
Hole diameter	25mm	25mm	25mm	25mm	25mm
Weight	480±50g	480±50g	480±50g	520±50g	520±50g

# High-precision Current Sensor

# AIT SERIES

## AIT500~AIT1500

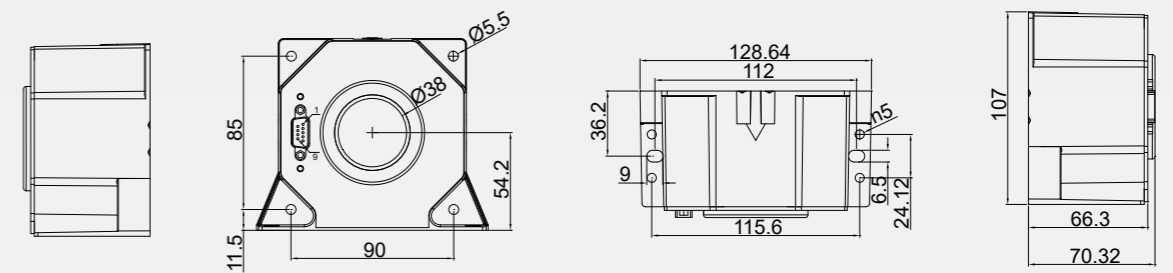

Product model	AIT500-SG	AIT600-SG	AIT700-SG	AIT1000-SG	AIT1500-SG
Primary rated DC current/ $I_{PN\_DC}$	±500A	±600A	±700A	±1000A	±1500A
Primary rated AC RMS/ $I_{PN}$	353A	424A	495A	707A	1060A
Primary overload current/ $I_{PM}$	±600A	±720A	±840A	±1200A	±1600A
Supply voltage/ $V_C$	±15V	±15V	±15V	±15V	±15V
Standby power consumption current/ $I_{PWR}$	±30mA	±30mA	±30mA	±30mA	±30mA
Transformation ratio (primary: secondary)/ $K_N$	1500: 1	1500: 1	1750: 1	1500: 1	1000: 1
Rated output current/ $I_{SN}$	333mA	400mA	400mA	667mA	1500mA
Accuracy/ $X_G$	10ppm	10ppm	10ppm	10ppm	10ppm
Linearity/ $\epsilon_L$	2ppm	2ppm	2ppm	2ppm	2ppm
Bandwidth/BW (3dB)	500kHz	500kHz	500kHz	500kHz	500kHz
Response time/ $t_r$	1μs	1μs	1μs	1μs	1μs
Current change rate/ $di/dt$	100A/μs	100A/μs	100A/μs	100A/μs	100A/μs
Zero offset current/ $I_{OT}$	±5μA	±5μA	±5μA	±5μA	±5μA
Operating temperature/ $T_A$	-40°C~85°C	-40°C~85°C	-40°C~85°C	-40°C~85°C	-40°C~85°C
Installation method	Disc installation	Disc installation	Disc installation	Disc installation	Disc installation
Hole diameter	38mm	38mm	38mm	38mm	38mm
Weight	1150±80g	1150±80g	1150±80g	1150±80g	1150±80g

# High-precision Current Sensor

## AIT SERIES

### AIT1500-D50~AIT4000-D90

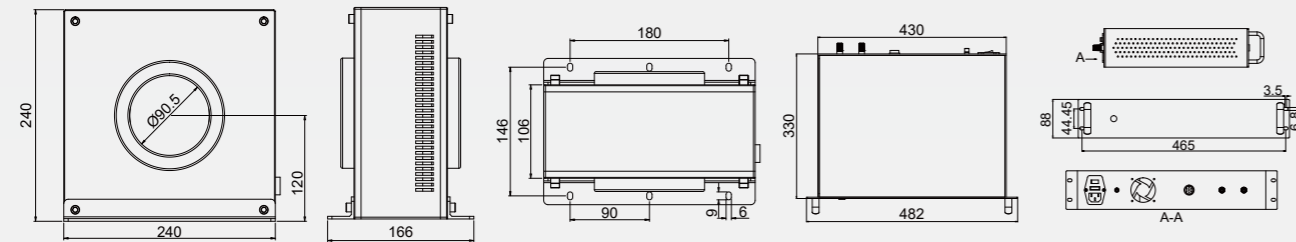
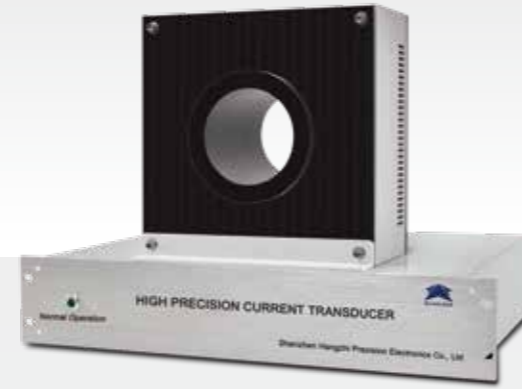

Product model	AIT1500-D50	AIT2000-D90	AIT3000-D90	AIT4000-D90
Primary rated DC current/ $I_{PN\_DC}$	±1500A	±2000A	±3000A	±4000A
Primary rated AC RMS/ $I_{PN}$	1060A	1414A	2121A	2828A
Primary overload current/ $I_{PM}$	±1650A	±2200A	±3300A	±4400A
Supply voltage/ $V_C$	Current 220V	Current 220V	Current 220V	Current 220V
Transformation ratio (primary: secondary)/ $K_N$	1500: 1	2000: 1	3000: 1	4000: 1
Rated output current/ $I_{SN}$	1000mA	1000mA	1000mA	1000mA
Accuracy/ $X_G$	50ppm	50ppm	50ppm	50ppm
Linearity/ $\epsilon_L$	20ppm	20ppm	20ppm	20ppm
Bandwidth/BW (3dB)	300kHz	80kHz	50kHz	50kHz
Response time/ $t_r$	1μs	1μs	1μs	1μs
Current change rate/di/dt	100A/μs	100A/μs	100A/μs	100A/μs
Zero offset current/ $I_{OT}$	±5μA	±5μA	±5μA	±5μA
Operating temperature/ $T_A$	-40°C~85°C	-40°C~85°C	-40°C~85°C	-40°C~85°C
Installation method	Disc installation	Disc installation	Disc installation	Disc installation
Hole diameter	50mm	90mm	90mm	90mm
Weight	8.5±1kg	9±1kg	9.5±1kg	15.5±1kg

# High-precision Current Sensor

## AIT SERIES

### AIT5000-D160~AIT10000-D120

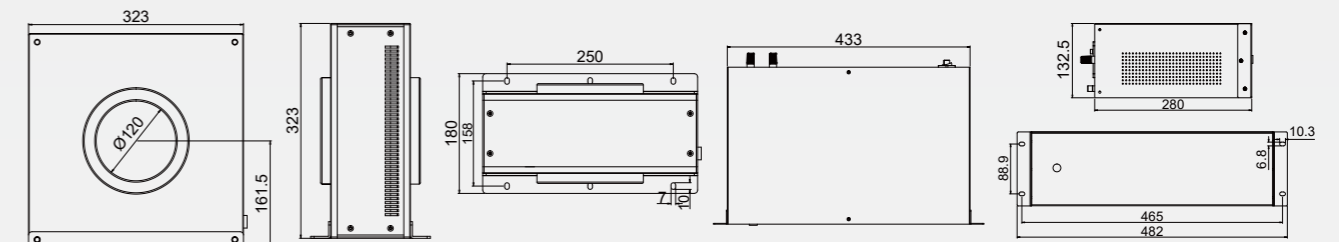
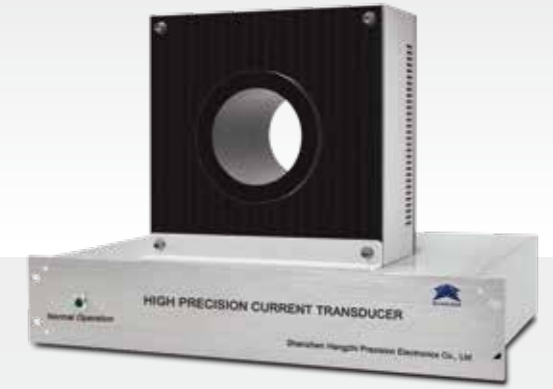

Product model	AIT5000-D160	AIT6000-D120	AIT8000-D120	AIT10000-D120
Primary rated DC current/ $I_{PN\_DC}$	±5000A	±6000A	±8000A	±10000A
Primary rated AC RMS/ $I_{PN}$	3535A	4242A	5600A	7072A
Primary overload current/ $I_{PM}$	±5500A	±6600A	±8000A	±10000A
Supply voltage/ $V_C$	Current 220V	Current 220V	Current 220V	Current 220V
Transformation ratio (primary: secondary)/ $K_N$	6000: 1	6000: 1	4000: 1	5000: 1
Rated output current/ $I_{SN}$	1000mA	1000mA	2000mA	2000mA
Accuracy/ $X_G$	50ppm	50ppm	50ppm	100ppm
Linearity/ $\epsilon_L$	20ppm	20ppm	20ppm	20ppm
Bandwidth/BW (3dB)	50kHz	50kHz	30kHz	20kHz
Response time/ $t_r$	1μs	1μs	1μs	1μs
Current change rate/di/dt	100A/μs	100A/μs	100A/μs	100A/μs
Zero offset current/ $I_{OT}$	±5μA	±5μA	±5μA	±5μA
Operating temperature/ $T_A$	-40°C~85°C	-40°C~85°C	-40°C~85°C	-40°C~85°C
Installation method	Disc installation	Disc installation	Disc installation	Disc installation
Hole diameter	160mm	120mm	120mm	120mm
Weight	23±2kg	23±2kg	28±2.25kg	28±2.25kg

# High-precision Current Sensor

## AIT SERIES

### AIT10-10V~AIT60-10V

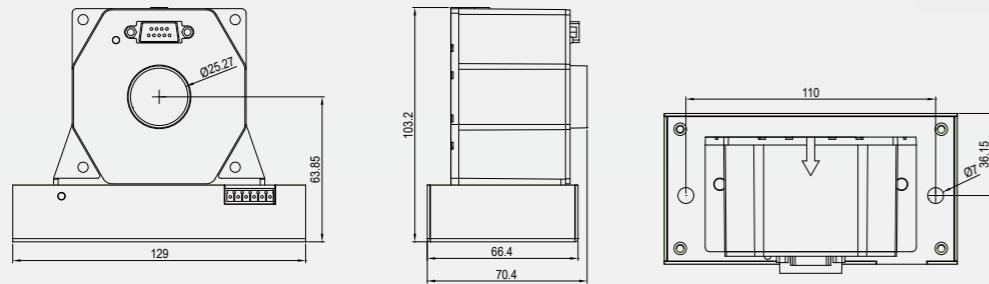

Product model	AIT10-10V	AIT20-10V	AIT30-10V	AIT50-10V	AIT60-10V
Primary rated DC current/ $I_{PN\_DC}$	±10A	±20A	±30A	±50A	±60A
Primary rated AC RMS/ $I_{PN}$	7.8A	14A	21A	35A	43A
Primary overload current/ $I_{PM}$	±12A	±24A	±36A	±60A	±72A
Supply voltage/ $V_c$	±15V	±15V	±15V	±15V	±15V
Standby power consumption current/ $I_{PWR}$	±40mA	±40mA	±40mA	±40mA	±40mA
Transformation ratio (primary: secondary)/ $K_N$	1000mV/A	500mV/A	333.3mV/A	200mV/A	166.7mV/A
Rated output current/ $I_{SN}$	±10V	±10V	±10V	±10V	±10V
Accuracy/ $X_G$	50ppm	50ppm	50ppm	50ppm	50ppm
Linearity/ $\epsilon_L$	10ppm	10ppm	10ppm	10ppm	10ppm
Bandwidth/BW(3dB)	500kHz	500kHz	500kHz	500kHz	500kHz
Response time/ $t_r$	7μs	7μs	7μs	7μs	7μs
Voltage variation rate/ $di/dt$	1.5V/μs	1.5V/μs	1.5V/μs	1.5V/μs	1.5V/μs
Operating temperature/ $T_A$	-40°C~85°C	-40°C~85°C	-40°C~85°C	-40°C~85°C	-40°C~85°C
Installation method	Disc installation	Disc installation	Disc installation	Disc installation	Disc installation
Hole diameter	25mm	25mm	25mm	25mm	25mm
Weight	800±60g	800±60g	800±60g	800±60g	800±60g

# High-precision Current Sensor

## AIT SERIES

### AIT100-10V~AIT400-10V

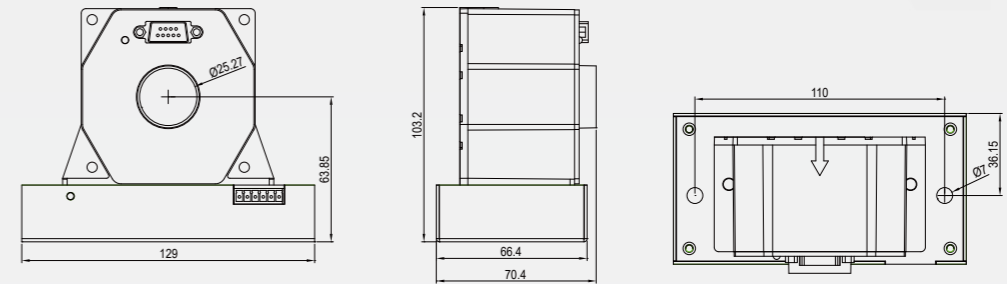

Product model	AIT100-10V	AIT200-10V	AIT300-10V	AIT400-10V
Primary rated DC current/ $I_{PN\_DC}$	±100A	±200A	±300A	±400A
Primary rated AC RMS/ $I_{PN}$	70A	140A	212A	282A
Primary overload current/ $I_{PM}$	±120A	±240A	±360A	±480A
Supply voltage/ $V_c$	±15V	±15V	±15V	±15V
Standby power consumption current/ $I_{PWR}$	±40mA	±40mA	±40mA	±40mA
Transformation ratio (primary: secondary)/ $K_N$	100mV/A	50mV/A	33.3mV/A	25mV/A
Rated output current/ $I_{SN}$	±10V	±10V	±10V	±10V
Accuracy/ $X_G$	50ppm	50ppm	50ppm	50ppm
Linearity/ $\epsilon_L$	10ppm	10ppm	10ppm	10ppm
Bandwidth/BW(3dB)	500kHz	500kHz	500kHz	500kHz
Response time/ $t_r$	7μs	7μs	7μs	7μs
Voltage variation rate/ $di/dt$	1.5V/μs	1.5V/μs	1.5V/μs	1.5V/μs
Operating temperature/ $T_A$	-40°C~85°C	-40°C~85°C	-40°C~85°C	-40°C~85°C
Installation method	Disc installation	Disc installation	Disc installation	Disc installation
Hole diameter	25mm	25mm	25mm	25mm
Weight	860±60g	860±60g	860±60g	860±60g

# High-precision Current Sensor

# AIT SERIES

## AIT600-10V~AIT1500-10V

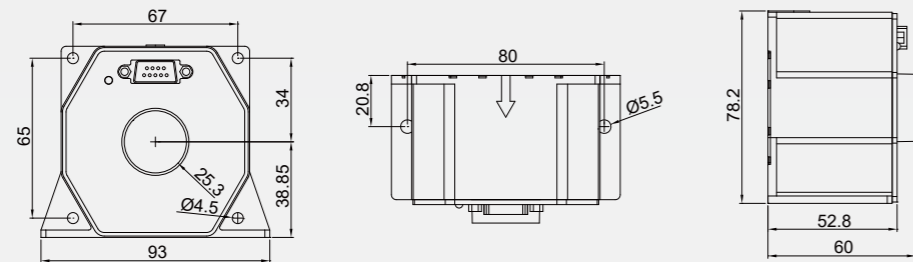

Product model	AIT600-10V	AIT700-10V	AIT1000-10V	AIT1500-10V
Primary rated DC current/ $I_{PN\_DC}$	±600A	±700A	±1000A	±1500A
Primary rated AC RMS/ $I_{PN}$	424A	500A	707A	1000A
Primary overload current/ $I_{PM}$	±720A	±840A	±1200A	±1600A
Supply voltage/ $V_c$	±15V	±15V	±15V	±15V
Standby power consumption current/ $I_{PWR}$	±40mA	±40mA	±40mA	±40mA
Transformation ratio (primary: secondary)/ $K_N$	16.7mV/A	14.3mV/A	10mV/A	6.7mV/A
Rated output current/ $U_{SN}$	±10V	±10V	±10V	±10V
Accuracy/ $X_G$	50ppm	50ppm	50ppm	50ppm
Linearity/ $\epsilon_L$	10ppm	10ppm	10ppm	10ppm
Bandwidth/BW(3dB)	500kHz	500kHz	500kHz	500kHz
Response time/ $t_r$	7μs	7μs	7μs	7μs
Current change rate/ $di/dt$	1.5V/μs	1.5V/μs	1.5V/μs	1.5V/μs
Operating temperature/ $T_A$	-40°C~85°C	-40°C~85°C	-40°C~85°C	-40°C~85°C
Installation method	Disc installation	Disc installation	Disc installation	Disc installation
Hole diameter	38mm	38mm	38mm	38mm
Weight	1465±100g	1465±100g	1465±100g	1465±100g

# TYPICAL APPLICATIONS

## AIT Series



### Medical equipment - magnetic resonance imaging (MRI)

The applied magnetic field, achieved by the gradient coil current controlled by a gradient amplifier, limits the MRI quality. As a result, the imaging quality is limited by the ability to measure and adjust the current in the gradient coil correctly.

The Hangzhi AIT series measurement level high-precision current sensor has 10ppm high accuracy, extremely low linearity error, bandwidth up to 800kHz, minimal temperature difference and zero difference, and strong anti-interference properties, allowing it to meet the ultra-high requirements of MRI equipment perfectly.



### High-precision power measurement (paired with the power analyzer)

High-precision power testing is required for wind turbines, photovoltaic inverters, new energy vehicle onboard inverters, motors, and metrology calibration laboratories.

Efficiency testing must be computed based on input and output power but cannot be measured directly. As a result, measurement inaccuracies will be compounded by input and output power errors. Only high-precision power analyzers paired with high-precision current sensors can assure measurement results, especially for power electronic devices with more than 95% measurement efficiency.



### High-precision equipment calibration

Hangzhi high-precision current sensors, with stability and accuracy at the PPM level, are highly accurate and cost-efficient for traditional and high-performance industrial testing equipment, making them a calibration benchmark recognized by many laboratories.



### Other high-precision applications

Power supply system with high stability, high energy physics accelerator, battery test system, precise motor control, etc.

High-precision split core current sensor

# CIT SERIES

CIT100~CIT1500

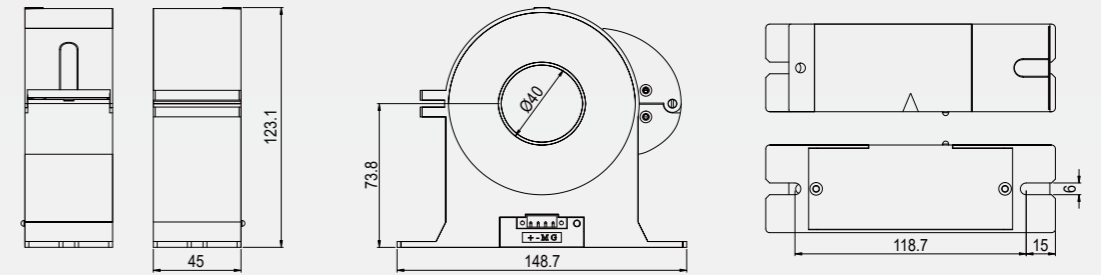
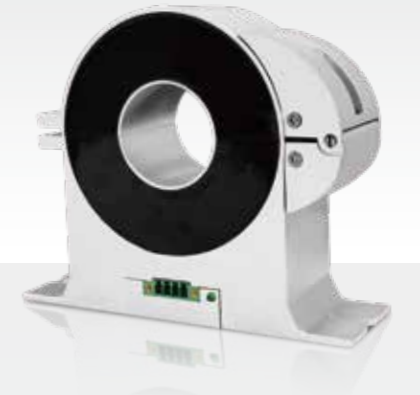

Product model	CIT100	CIT200	CIT400	CIT600	CIT1000	CIT1500
Primary rated DC current/ $I_{PN\_DC}$	±100A	±200A	±400A	±600A	±1000A	±1500A
Primary rated AC RMS/ $I_{PN}$	70A	140A	282A	424A	707A	1060A
Primary overload current/ $I_{PM}$	±120A	±240A	±480A	±720A	±1200A	±1650A
Supply voltage/ $V_c$	±15V	±15V	±15V	±15V	±15V	±15V
Standby power consumption current/ $I_{PWR}$	±50mA	±50mA	±50mA	±50mA	±50mA	±50mA
Transformation ratio (primary: secondary)/ $K_N$	1000: 1	1000: 1	1000: 1	1000: 1	1000: 1	1000: 1
Rated output current/ $I_{SN}$	100mA	200mA	400mA	600mA	1000mA	1500mA
Accuracy/ $X_G$	0.05%	0.05%	0.05%	0.05%	0.05%	0.05%
Linearity/ $\epsilon_L$	0.02%	0.02%	0.02%	0.02%	0.02%	0.02%
Bandwidth/BW(3dB)	350kHz	350kHz	350kHz	350kHz	350kHz	350kHz
Response time/ $t_r$	2μs	2μs	2μs	2μs	2μs	2μs
Current change rate/ $di/dt$	100A/μs	100A/μs	100A/μs	100A/μs	100A/μs	100A/μs
Zero offset current/ $I_{or}$	±30μA	±30μA	±30μA	±30μA	±30μA	±30μA
Operating temperature/ $T_A$	-30°C~75°C	-30°C~75°C	-30°C~75°C	-30°C~75°C	-30°C~75°C	-30°C~75°C
Installation method	Disc installation	Disc installation	Disc installation	Disc installation	Disc installation	Disc installation
Hole diameter	40mm	40mm	40mm	40mm	40mm	40mm
Weight	1050g	1050g	1050g	1050g	1050g	1050g

Industrial control level current sensor

# IIT SERIES

IIT30~IIT400

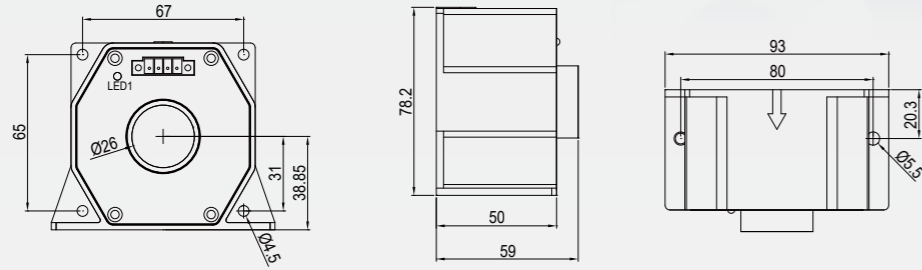

Industrial control level current sensor

# IIT SERIES

IIT500~IIT1500

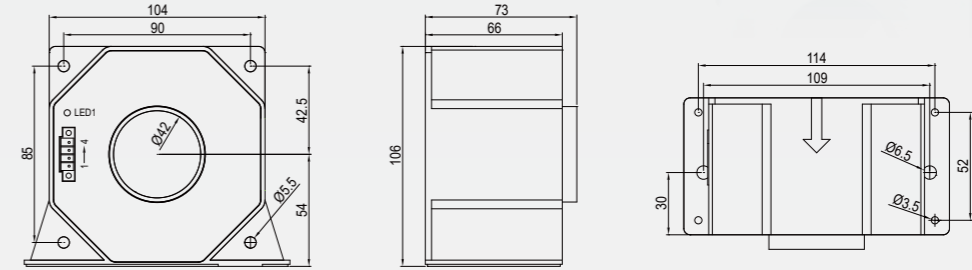

Product model	IIT30	IIT60	IIT100	IIT200	IIT300	IIT400
Primary rated DC current/ $I_{PN\_DC}$	±30A	±60A	±100A	±200A	±300A	±400A
Primary rated AC RMS/ $I_{PN}$	21.2A	42.4A	70.7A	141A	212A	283A
Primary overload current/ $I_{PM}$	±42A	±72A	±120A	±240A	±360A	±480A
Power current/ $I_{PWR}$	±30mA	±30mA	±30mA	±30mA	±30mA	±30mA
Rated output current/ $I_{SN}$	±50mA	±100mA	±100mA	±100mA	±150mA	±200mA
Transformation ratio (primary: secondary)/ $K_N$	600: 1	600: 1	1000: 1	2000: 1	2000: 1	2000: 1
Secondary rated signal/ $I_{SN}$	50mA	100mA	100mA	100mA	150mA	200mA
Accuracy/ $X_G$	0.02%	0.02%	0.02%	0.02%	0.02%	0.02%
Linearity/ $\epsilon_L$	20ppm	20ppm	20ppm	20ppm	20ppm	20ppm
Bandwidth/ $BW(3dB)$	100kHz	100kHz	100kHz	100kHz	100kHz	100kHz
Response time/ $t_r$	1μs	1μs	1μs	1μs	1μs	1μs
Current change rate/ $di/dt$	200A/μs	200A/μs	200A/μs	200A/μs	200A/μs	200A/μs
Zero offset current/ $I_{0r}$	±10μA	±10μA	±10μA	±10μA	±10μA	±10μA
Supply voltage/ $V_c$	±15V	±15V	±15V	±15V	±15V	±15V
Operating temperature/ $T_A$	-40°C~85°C	-40°C~85°C	-40°C~85°C	-40°C~85°C	-40°C~85°C	-40°C~85°C
Installation method	Disc installation	Disc installation	Disc installation	Disc installation	Disc installation	Disc installation
Hole diameter	26mm	26mm	26mm	26mm	26mm	26mm
Weight	370±50g	370±50g	370±50g	420±50g	420±50g	420±50g

Product model	IIT500	IIT600	IIT700	IIT1000	IIT1500
Primary rated DC current/ $I_{PN\_DC}$	±500A	±600A	±700A	±1000A	±1500A
Primary rated AC RMS/ $I_{PN}$	354A	424A	495A	707A	1060A
Primary overload current/ $I_{PM}$	±600A	±720A	±840A	±1200A	±1600A
Power current/ $I_{PWR}$	±30mA	±30mA	±30mA	±30mA	±30mA
Rated output current/ $I_{SN}$	±330mA	±400mA	±400mA	±667mA	±1500mA
Transformation ratio (primary: secondary)/ $K_N$	1500: 1	1500: 1	1750: 1	1500: 1	1000: 1
Secondary rated signal/ $I_{SN}$	330mA	400mA	400mA	667mA	1500mA
Accuracy/ $X_G$	0.02%	0.02%	0.02%	0.02%	0.02%
Linearity/ $\epsilon_L$	20ppm	20ppm	20ppm	20ppm	20ppm
Bandwidth/ $BW(3dB)$	100kHz	100kHz	100kHz	100kHz	100kHz
Response time/ $t_r$	1μs	1μs	1μs	1μs	1μs
Current change rate/ $di/dt$	200A/μs	200A/μs	200A/μs	200A/μs	200A/μs
Zero offset current/ $I_{0r}$	±10μA	±10μA	±10μA	±10μA	±10μA
Supply voltage/ $V_c$	±15V	±15V	±15V	±15V	±15V
Operating temperature/ $T_A$	-40°C~85°C	-40°C~85°C	-40°C~85°C	-40°C~85°C	-40°C~85°C
Installation method	Disc installation	Disc installation	Disc installation	Disc installation	Disc installation
Hole diameter	42mm	42mm	42mm	42mm	38mm
Weight	1000±80g	1000±80g	1000±80g	1000±80g	1000±80g

Industrial control level current sensor

# IIT SERIES

IIT10-10V~IIT60-10V

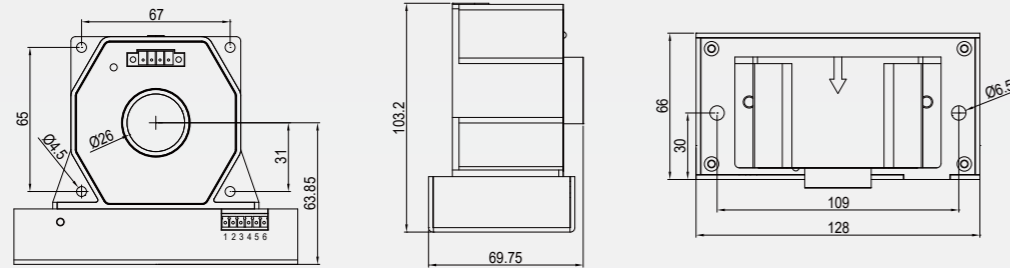

Industrial control level current sensor

# IIT SERIES

IIT100-10V~IIT400-10V

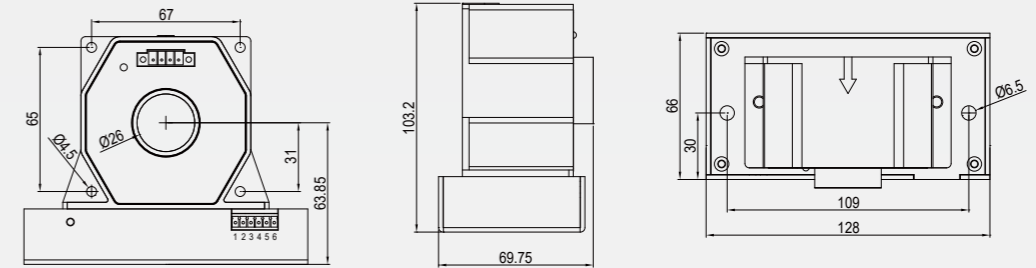

Product model	IIT10-10V	IIT20-10V	IIT50-10V	IIT60-10V
Primary rated DC current/ $I_{PN\_DC}$	±10A	±20A	±50A	±60A
Primary rated AC RMS/ $I_{PN}$	7A	14A	36A	42.4A
Primary overload current/ $I_{PM}$	±12A	±24A	±60A	±72A
Supply voltage/ $V_c$	±15V	±15V	±15V	±15V
Standby power consumption current/ $I_{PWR}$	±40mA	±40mA	±40mA	±40mA
Transformation ratio (primary: secondary)/ $K_N$	1000mV/A	500mV/A	200mV/A	166.7mV/A
Rated output voltage/ $U_{SN}$	±10V	±10V	±10V	±10V
Accuracy/ $X_G$	0.02%	0.02%	0.02%	0.02%
Linearity/ $\epsilon_L$	50ppm	50ppm	50ppm	50ppm
Bandwidth/BW(3dB)	100kHz	100kHz	100kHz	100kHz
Response time/ $t_r$	10μs	10μs	10μs	10μs
Voltage variation rate/ $di/dt$	1V/μs	1V/μs	1V/μs	1V/μs
Operating temperature/ $T_A$	-40°C~85°C	-40°C~85°C	-40°C~85°C	-40°C~85°C
Installation method	Disc installation	Disc installation	Disc installation	Disc installation
Hole diameter	26mm	26mm	26mm	26mm
Weight	970±10g	970±10g	685±60g	685±60g

Product model	IIT100-10V	IIT200-10V	IIT300-10V	IIT400-10V
Primary rated DC current/ $I_{PN\_DC}$	±100A	±200A	±300A	±400A
Primary rated AC RMS/ $I_{PN}$	70.7A	141A	212A	283A
Primary overload current/ $I_{PM}$	±120A	±240A	±360A	±480A
Supply voltage/ $V_c$	±15V	±15V	±15V	±15V
Standby power consumption current/ $I_{PWR}$	±40mA	±40mA	±40mA	±40mA
Transformation ratio (primary: secondary)/ $K_N$	100mV/A	50mV/A	33.3mV/A	25mV/A
Rated output voltage/ $U_{SN}$	±10V	±10V	±10V	±10V
Accuracy/ $X_G$	0.02%	0.02%	0.02%	0.02%
Linearity/ $\epsilon_L$	50ppm	50ppm	50ppm	50ppm
Bandwidth/BW(3dB)	100kHz	100kHz	100kHz	100kHz
Response time/ $t_r$	10μs	10μs	10μs	10μs
Voltage variation rate/ $di/dt$	1V/μs	1V/μs	1V/μs	1V/μs
Operating temperature/ $T_A$	-40°C~85°C	-40°C~85°C	-40°C~85°C	-40°C~85°C
Installation method	Disc installation	Disc installation	Disc installation	Disc installation
Hole diameter	26mm	26mm	26mm	26mm
Weight	685±60g	685±60g	735±60g	735±60g



Industrial control level current sensor

# IIT SERIES

IIT500-10V~IIT1500-10V

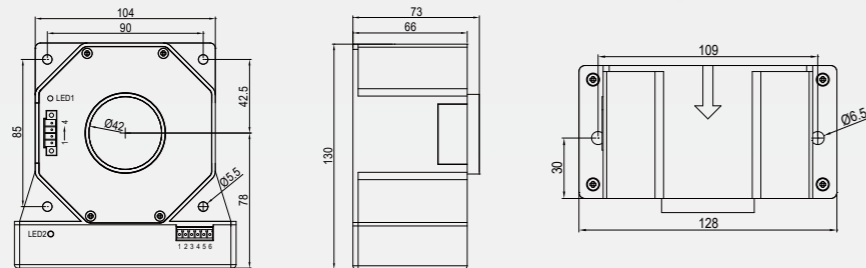

Product model	IIT500-10V	IIT600-10V	IIT700-10V	IIT1000-10V	IIT1500-10V
Primary rated DC current/ $I_{PN\_DC}$	±500A	±600A	±700A	±1000A	±1500A
Primary rated AC RMS/ $I_{PN}$	354A	424A	495A	707A	1060
Primary overload current/ $I_{PM}$	±600A	±720A	±840A	±1200A	±1600A
Supply voltage/ $V_c$	±15V	±15V	±15V	±15V	±15V
Standby power consumption current/ $I_{PWR}$	±40mA	±40mA	±40mA	±40mA	±40mA
Transformation ratio (primary: secondary)/ $K_N$	20mV/A	16.7mV/A	14.3mV/A	10mV/A	6.6mV/A
Rated output voltage/ $U_{SN}$	±10V	±10V	±10V	±10V	±10V
Accuracy/ $X_G$	0.02%	0.02%	0.02%	0.02%	0.02%
Linearity/ $\epsilon_L$	50ppm	50ppm	50ppm	50ppm	50ppm
Bandwidth/BW(3dB)	100kHz	100kHz	100kHz	100kHz	100kHz
Response time/ $t_r$	10μs	10μs	10μs	10μs	10μs
Voltage variation rate/ $di/dt$	1V/μs	1V/μs	1V/μs	1V/μs	1V/μs
Operating temperature/ $T_A$	-40°C~85°C	-40°C~85°C	-40°C~85°C	-40°C~85°C	-40°C~85°C
Installation method	Disc installation	Disc installation	Disc installation	Disc installation	Disc installation
Hole diameter	42mm	42mm	42mm	42mm	42mm
Weight	1250±20g	1250±20g	1250±20g	1250±20g	1250±20g



# TYPICAL APPLICATIONS

IIT series



## © Lithium battery testing devices

The battery formation process requires a high level of error in the measurement of lithium battery charging and discharging current and voltage, so a higher accuracy current sensor is required to ensure that the overall accuracy of the formation equipment meets high requirements and standards. The formation process also has rigorous temperature requirements; thus, the current sensor's temperature drift performance is critical.

IIT high-precision current sensor (precision:0.02%) has the temperature influence of 1PPM/10 degrees and outstanding temperature drift consistency, greatly Improving overall reliability and safety and widely applied in chemical synthesis equipment



## © Renewable energy

The Hangzhi IIT series industrial control level current sensor can control the energy flow and waveform transmitted from the renewable energy system to the power grid. They measure current to enable windmills, solar energy, photovoltaic, and other devices to run as efficiently as possible.



## © Industrial electrical testing equipment

With the popularization of new energy power applications, there is a growing demand for DC detection applications in industrial electrical measuring devices. The Hangzhi industrial control level current sensor is a high-quality DC measuring option.



## © Other applications

Industrial healthcare, energy equipment, new energy industry, etc.

# Hall replacement current sensor

# HIT SERIES

## HIT30~HIT305

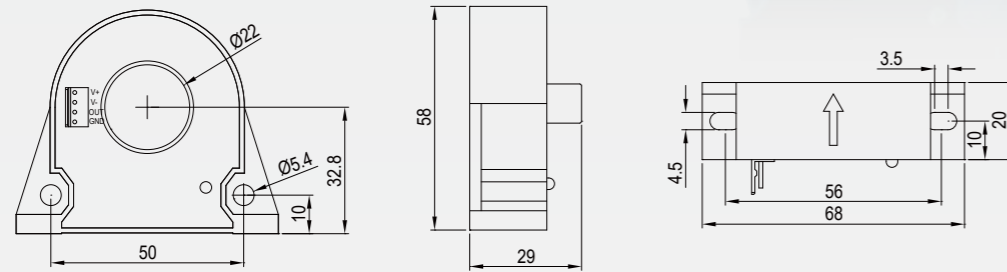
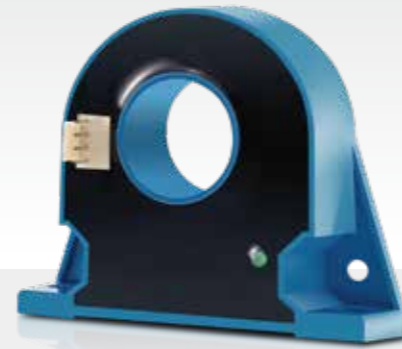

Product model	HIT30	HIT50	HIT60	HIT100	HIT200	HIT300	HIT305
Primary rated DC current/ $I_{PN\_DC}$	±30A	±50A	±60A	±100A	±200A	±300A	±300A
Primary rated AC RMS/ $I_{PN}$	21A	35A	42A	70.7A	141A	212A	212A
Primary overload current/ $I_{PM}$	±36A	±60A	±72A	±120A	±240A	±360A	±360A
Power current/ $I_{PWR}$	±30mA	±30mA	±30mA	±30mA	±30mA	±30mA	±30mA
Rated output current/ $I_{SN}$	±50mA	±50mA	±100mA	±100mA	±100mA	±100mA	±150mA
Transformation ratio (primary: secondary)/ $K_N$	600:1	1000:1	600:1	1000:1	2000:1	3000:1	2000:1
Secondary rated signal/ $I_{SN}$	50mA	50mA	100mA	100mA	100mA	100mA	150mA
Accuracy/ $X_G$	0.05%	0.05%	0.05%	0.05%	0.05%	0.05%	0.05%
Linearity/ $\epsilon_L$	50ppm	50ppm	50ppm	50ppm	50ppm	50ppm	50ppm
Bandwidth/BW(3dB)	100kHz	100kHz	100kHz	100kHz	100kHz	100kHz	100kHz
Response time/ $t_r$	1μs	1μs	1μs	1μs	1μs	1μs	1μs
Current change rate/di/dt	100A/μs	100A/μs	100A/μs	100A/μs	100A/μs	100A/μs	100A/μs
Zero offset current/ $I_{0r}$	±40μA	±10μA	±10μA	±10μA	±10μA	±10μA	±10μA
Supply voltage/ $V_c$	±15V	±15V	±15V	±15V	±15V	±15V	±15V
Operating temperature/ $T_A$	-40°C~85°C	-40°C~85°C	-40°C~85°C	-40°C~85°C	-40°C~85°C	-40°C~85°C	-40°C~85°C
Installation method	Disc installation	Disc installation	Disc installation	Disc installation	Disc installation	Disc installation	Disc installation
Hole diameter	22mm	22mm	22mm	22mm	22mm	22mm	22mm
Weight	80±10g	80±10g	80±10g	80±10g	80±10g	80±10g	80±10g

# Hall replacement current sensor

# HIT SERIES

## HIT500~HIT600

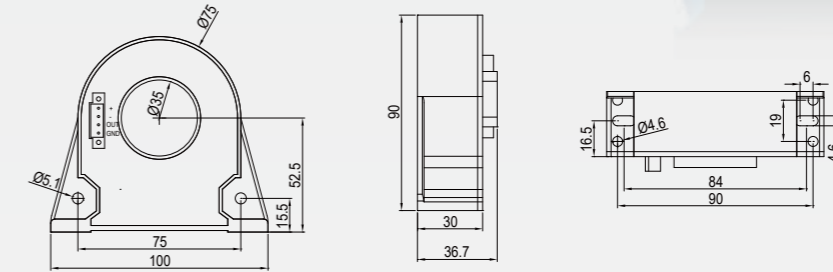
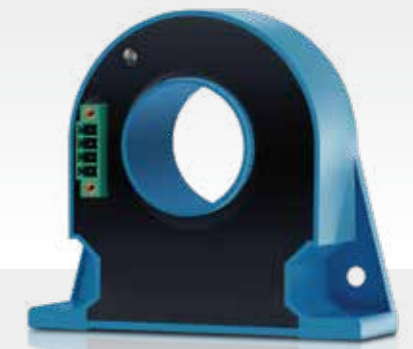

Product model	HIT500	HIT600
Primary rated DC current/ $I_{PN\_DC}$	±500A	±600A
Primary rated AC RMS/ $I_{PN}$	354A	424A
Primary overload current/ $I_{PM}$	±600A	±720A
Power current/ $I_{PWR}$	±30mA	±30mA
Rated output current/ $I_{SN}$	±250mA	±200mA
Transformation ratio (primary: secondary)/ $K_N$	2000:1	3000:1
Secondary rated signal/ $I_{SN}$	250mA	200mA
Accuracy/ $X_G$	0.05%	0.05%
Linearity/ $\epsilon_L$	50ppm	50ppm
Bandwidth/BW(3dB)	100kHz	100kHz
Response time/ $t_r$	1μs	1μs
Current change rate/di/dt	100A/μs	100A/μs
Zero offset current/ $I_{0r}$	±10μA	±10μA
Supply voltage/ $V_c$	±15V	±15V
Operating temperature/ $T_A$	-40°C~85°C	-40°C~85°C
Installation method	Disc installation	Disc installation
Hole diameter	35mm	35mm
Weight	320±30g	320±30g



# TYPICAL APPLICATIONS

## HIT series



### © Renewable energy

The HIT series current sensors can demonstrate their capability in current feedback in domains such as photovoltaic, solar, and wind energy inverters. It can control the energy flow and waveform transmitted from the renewable energy system to the power grid. They measure current to enable windmills, solar energy, photovoltaic, and other devices to run as efficiently as possible.



### © Power supply system

HIT sensors can isolate and measure the output current of the power supply system in the power supply system, which means that the sensor output signal is completely electrically isolated from the power supply output current, making it easier to adjust and process the sensor output signal. By adjusting and setting this signal and controlling the power supply's output current through feedback, the power supply's output current will stop increasing when it reaches the system's design power output. This, therefore, limits its output power and guards it against damage brought on by variations in electrical load.



### © Automobile charger

The focus of attention and development goal in all countries are now electric vehicles with zero emission features due to the current prominence of environmental and energy challenges. But before it can be put into use, the issue of charging endurance must be resolved. For this reason, charging piles for electric cars were developed. Charging piles often have fixed locations and provide similar purposes to conventional gas stations. These electric piles' current sensors are important electrical measurement components that help monitor the charging process and ensure charging safety.



### © Other applications

frequency converter, UPS, etc.

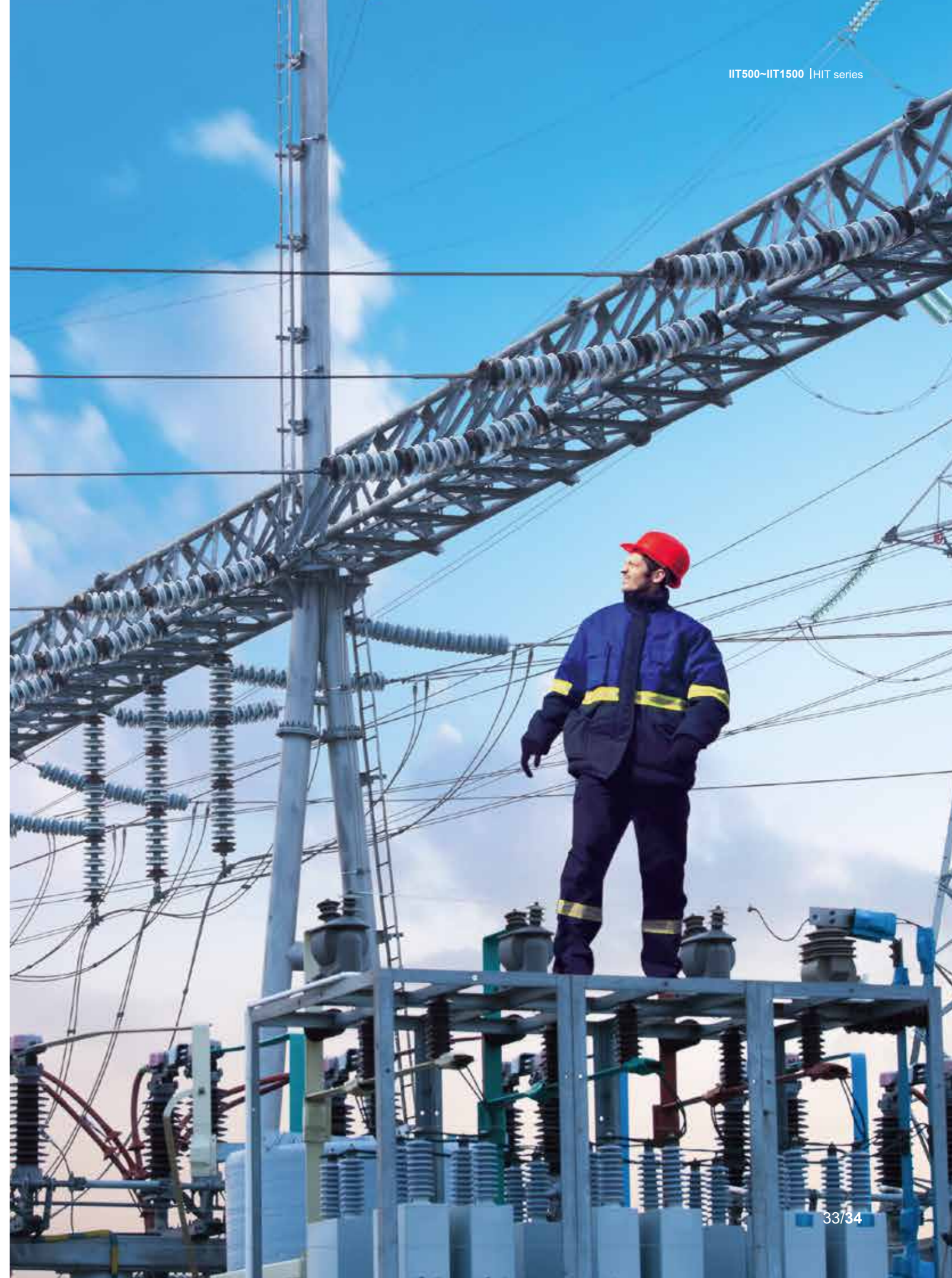

Residual current sensor

# RIT SERIES

RIT001M~RIT05M

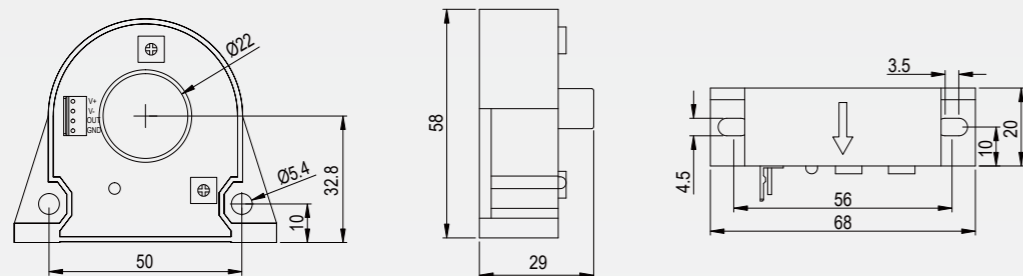
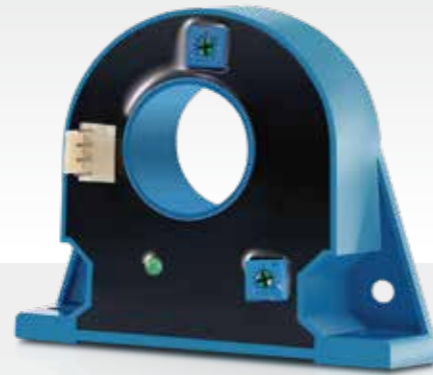

Product model	RIT001M	RIT002M	RIT01M	RIT02M	RIT05M
Primary rated DC current/ $I_{PN-DC}$	±10mA	±20mA	±100mA	±200mA	±500mA
Primary overload current/ $I_{PM}$	20mA	40mA	200mA	400mA	1A
Power current/ $I_{PWR}$	±30mA	±30mA	±30mA	±30mA	±30mA
Secondary rated signal/ $I_{SN}$	±1V	±1V	±1V	±1V	±1V
Accuracy/ $X_G$	1.0%	1.0%	0.2%	0.2%	0.2%
Linearity/ $\epsilon_L$	0.20%	0.20%	0.10%	0.10%	0.10%
Bandwidth/BW(3dB)	100kHz	100kHz	100kHz	100kHz	100kHz
Response time/ $t_r$	2ms	2ms	2ms	2ms	2ms
Zero offset voltage/ $I_{OT}$	±10mA	±10mA	±10mA	±10mA	±10mA
Supply voltage/ $V_c$	±15V	±15V	±15V	±15V	±15V
Operating temperature/ $T_A$	-40°C~85°C	-40°C~85°C	-40°C~85°C	-40°C~85°C	-40°C~85°C
Installation method	Disc installation	Disc installation	Disc installation	Disc installation	Disc installation
Hole diameter	22mm	22mm	22mm	22mm	22mm
Weight	80±10g	80±10g	80±10g	80±10g	80±10g

Residual current sensor

# RIT SERIES

RIT1M~RIT10M

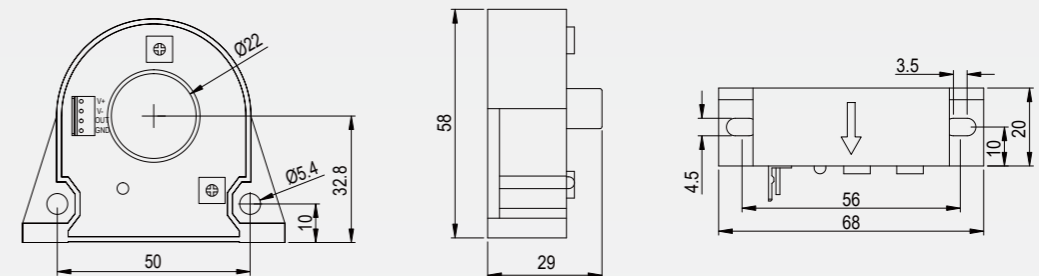
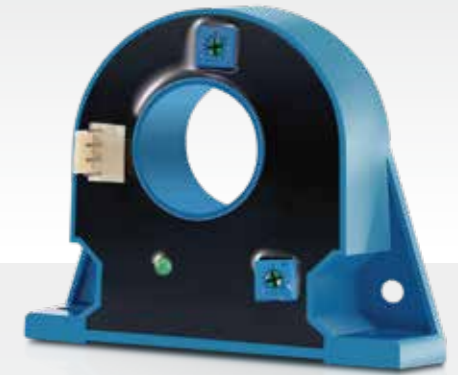

Product model	RIT1M	RIT2M	RIT3M	RIT5M	RIT10M
Primary rated DC current/ $I_{PN-DC}$	±1A	±2A	±3A	±5A	±10A
Primary overload current/ $I_{PM}$	2A	4A	6A	10A	20A
Power current/ $I_{PWR}$	±30mA	±30mA	±30mA	±30mA	±30mA
Secondary rated signal/ $I_{SN}$	±1V	±2V	±3V	±5V	±5V
Accuracy/ $X_G$	0.2%	0.2%	0.2%	0.2%	0.2%
Linearity/ $\epsilon_L$	0.10%	0.10%	0.10%	0.10%	0.2%
Bandwidth/BW(3dB)	100kHz	100kHz	100kHz	100kHz	100kHz
Response time/ $t_r$	2ms	2ms	2ms	2ms	2ms
Zero offset voltage/ $I_{OT}$	±10mA	±10mA	±10mA	±10mA	±10mA
Supply voltage/ $V_c$	±15V	±15V	±15V	±15V	±15V
Operating temperature/ $T_A$	-40°C~85°C	-40°C~85°C	-40°C~85°C	-40°C~85°C	-40°C~85°C
Installation method	Disc installation	Disc installation	Disc installation	Disc installation	Disc installation
Hole diameter	22mm	22mm	22mm	22mm	22mm
Weight	80±10g	80±10g	80±10g	80±10g	80±10g



# TYPICAL APPLICATIONS

RIT series

## © Industrial Internet

Regarding equipment's online status detection, it measures the instantaneous current value in a contactless manner in an isolated state, with a measurement range of 0.01 A to 5A.

## © DC distribution and consumption system

With the increasing DC load in large data centers, electric vehicle charging and swapping stations, communication equipment, and the high proportion and large capacity decentralized access of distributed DC power sources such as photovoltaics, etc., the DC characteristics of load, source, and storage of the current distribution network are becoming increasingly apparent. Compared to AC distribution systems, DC distribution systems with more advantages will be the development direction in the future.

The Hangzhi RIT series residual current sensors test actual DC systems' fault arc detection function. Its detection effect is still ideal, and it can achieve efficient, economical, fast, and accurate detection of fault arcs in multiple scenarios.

## © Test devices

Many tested products have a low current, requiring high testing accuracy and contactless measurement. The RIT high-precision residual current sensors adopt a wire through-hole test and can achieve a 0.2% testing accuracy.



Digital current sensor

# DIT SERIES

DIT60~DIT1000

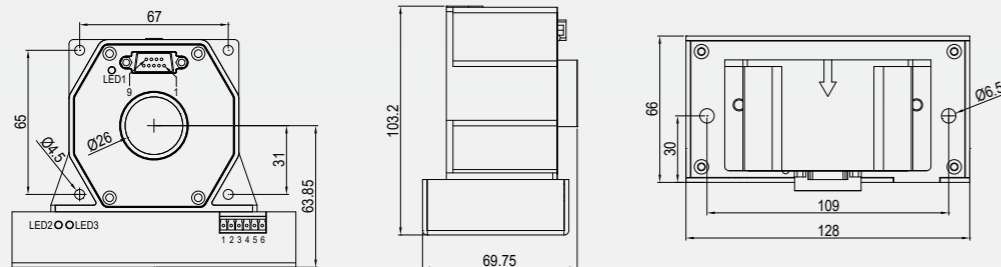

Product model	DIT60	DIT200	DIT300	DIT600	DIT1000
Primary rated DC current/ $I_{PN-DC}$	±60A	±200A	±300A	±600A	±1000A
Primary rated AC RMS/ $I_{PN}$	42A	141A	212A	424A	707A
Primary overload current/ $I_{PM}$	±72A	±240A	±360A	±720A	±1200A
Power current/ $I_{PWR}$	80mA@ $I_p=0A$ , 200mA@ $I_p=60A$	80mA@ $I_p=0A$ , 300mA@ $I_p=200A$	80mA@ $I_p=0A$ , 300mA@ $I_p=300A$	80mA@ $I_p=0A$ , 500mA@ $I_p=600A$	80mA@ $I_p=0A$ , 800mA@ $I_p=1000A$
Secondary rated signal/ $I_{SN}$	RS232/RS485 Digital signal	RS232/RS485 Digital signal	RS232/RS485 Digital signal	RS232/RS485 Digital signal	RS232/RS485 Digital signal
Accuracy/ $X_G$	0.02%	0.02%	0.02%	0.02%	0.02%
Bandwidth/BW(3dB)	1Hz	1Hz	1Hz	1Hz	1Hz
Response time/ $t_r$	1s	1s	1s	1s	1s
Zero offset voltage/ $I_{OT}$	10mA	10mA	10mA	10mA	10mA
Supply voltage/ $V_c$	±15V	±15V	±15V	±15V	±15V
Operating temperature/ $T_A$	10°C~35°C	10°C~35°C	10°C~35°C	10°C~35°C	10°C~35°C
Installation method	Disc installation	Disc installation	Disc installation	Disc installation	Disc installation
Hole diameter	26mm	26mm	26mm	42mm	42mm
Weight	680±10g	710±10g	750±10g	1400±10g	1400±10g



# TYPICAL APPLICATIONS

DIT series

## High current automatic charging system

Automatic charging vehicles (buses, trucks, shUPS, and other vehicles) require a high level of fast power supply. This fast-charging solution can help reduce urban noise and toxic substance emissions. It does not necessitate the purchase of uneconomical large and heavy batteries, as public transportation does, which adds to the expense.

During the rapid charging process, high-precision current monitoring is required to ensure charging control safety and prevent damage to automatic vehicles. Hangzhi's high-precision digital current sensor can fully meet customers' current monitoring of the charging process, giving highly reliable charging data.

## Power lithium battery cell testing device

Electric vehicle fires can be set off by a variety of circumstances, including thermal runaways caused by overcharging/over-discharging. Overcharging causes the positive electrode active chemicals to degrade, releasing much gas and heat. After exceeding a certain limit, explosion, combustion, etc., will occur. Furthermore, short circuits within the battery can result in combustion or explosion. Lithium-ion batteries are prone to lithium crystals during low-temperature charging, which can infiltrate the separator and form a short circuit between the positive and negative electrodes, resulting in thermal runaway. During the cell testing phase, the testing instruments can test the aforementioned phenomena in advance.

Hangzhi's current sensor for the power lithium battery cell testing devices can measure currents lower than 100mA with an accuracy of 0.01%. Its digital processing makes current signal acquisition easier for customers and greatly improves their usage efficiency.

## Other applications

Calibration of current sensors, solar cell production equipment, etc.



Automotive BMS current sensor

# BMS SERIES

BMS300A~BMS1500A

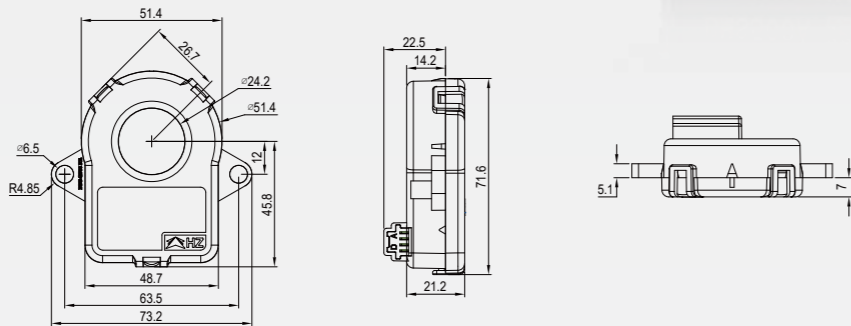

Product model	BMS300A	BMS500A	BMS1500A
Primary rated DC current/ $I_{PN\_DC}$	±300A	±500A	±1500A
Primary overload current/ $I_{PM}$	±350A	±530A	±1550A
Power current/ $I_{PWR}$	30mA@ $I_p=0A$ , 80mA@ $I_p=350A$	30mA@ $I_p=0A$ , 140mA@ $I_p=530A$	100mA@ $I_p=0A$ , 1300mA@ $I_p=500A$
Secondary rated signal/ $I_{SN}$	CAN disc installation	CAN disc installation	CAN disc installation
Accuracy/ $X_G$	0.5%	0.5%	0.5%
Linearity/ $\epsilon_L$	0.1%	0.1%	0.1%
Bandwidth/ $BW(3dB)$	100Hz	100Hz	20Hz
Response time/ $t_r$	10ms	10ms	10ms
Zero offset voltage/ $I_{OT}$	10mA	10mA	50mA
Supply voltage/ $V_c$	8~16V	8~16V	8~16V
Operating temperature/ $T_A$	-40°C~85°C	-40°C~85°C	-40°C~85°C
Installation method	Disc installation	Disc installation	Disc installation
Hole diameter	24.2mm	24.2mm	24.2mm
Weight	67g	67g	100g



## TYPICAL APPLICATIONS

BMS series

### Monitoring of BMS battery charging and discharging current for new energy vehicles

One scenario for the application of BMS in new energy vehicles is monitoring the charging and discharging current of the battery. Sensors are typically installed in the BDU (battery disconnect unit) or SBOX main major or secondary circuit to measure the total battery current. The current signal will be supplied to the BMS for charging and discharging control, assessment of battery SOC (residual capacity detection), and protection against overcurrent and overcharging. When this need is broken down into current measurement functions, there are requirements for global accuracy for current sensors and zero error requirements for small currents.

In terms of the current range, the peak current of the battery can reach 1200-1500A for high-performance electric vehicles with four-wheel drive and dual motor applications. Sensor accuracy of <1% is required to improve the accuracy of SOC estimation and battery consumption rate, and many customers have even recommended 0.5%. Customers want an increase in the electric control voltage from 400V to 800V for BDU active cooling and thermal management to improve the operational efficiency of the motor and reduce copper losses and costs.

Because there is a considerable cumulative error during SOC estimation, which seriously impacts SOC accuracy, the zero-point error is a more important metric for SOC estimation of BMS batteries than gain error. Hangzhi devices achieve exceptional zero-point error and global accuracy of 0.5% of the full range and full temperature, ensuring high SOC accuracy in high and low current charging processes. Because fluxgate technology does not have to consider the issue of heating and does not have the limitation of overcurrent overload, it is theoretically infinite and avoids the aging problem caused by shunt resistor heating.

For simpler applications, our fluxgate current sensors feature direct CAN signal output and do not require further calibration at the customer's system level. This saves customers significant development expense and time and avoids the additional temperature compensation and calibration required by using a shunt. It is also naturally insulated from the high-voltage bus, ensuring system safety.

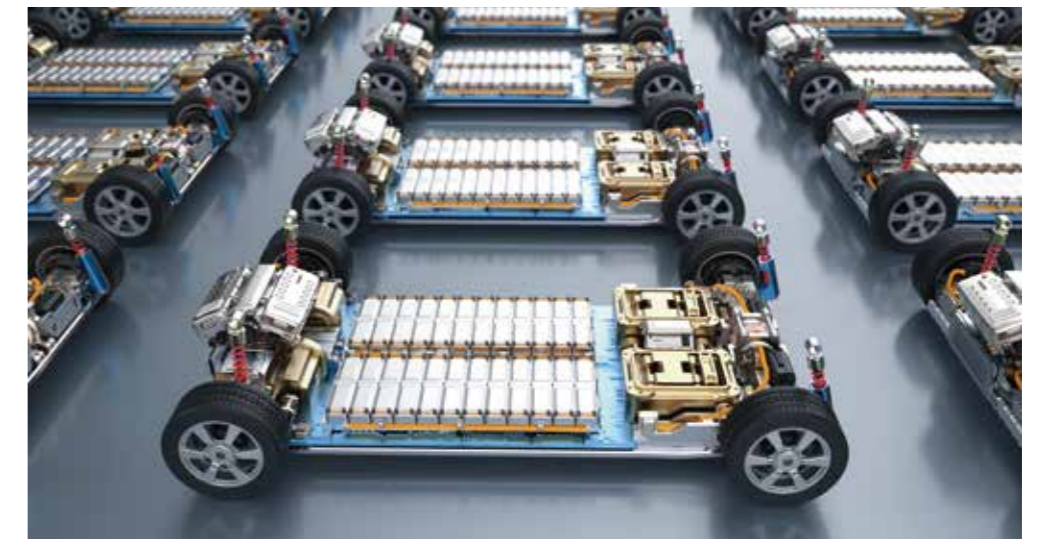

PCB mounted current sensor

# CAFR SERIES

CAFR-6A-NP~CAFR-50A-NP

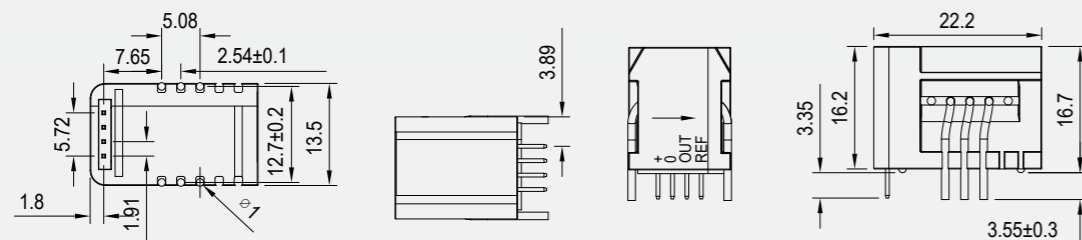

Product model	CAFR-6A-NP	CAFR-15A-NP	CAFR-25A-NP	CAFR-50A-NP
Primary rated current/ $I_{PN}$	±6	±15	±25	±50
Primary current measurement range/ $I_{PM}$	±20	±51	±85	±150
Power consumption current/ $I_c$	19mA	24mA	39mA	65mA
Output voltage/ $V_{out}$	$V_{out}=(V_c/5) \times (2.5+G_{th} \times I_p)$	$V_{out}=(V_c/5) \times (2.5+G_{th} \times I_p)$	$V_{out}=(V_c/5) \times (2.5+G_{th} \times I_p)$	$V_{out}=(V_c/5) \times (2.5+G_{th} \times I_p)$
Theoretical gain/ $G_{th}$	104.2	41.67	25	12.5
Accuracy/ $X_G$	±0.8%	±0.8%	±0.8%	±0.8%
Linearity/ $\epsilon_L$	±0.1	±0.1	±0.1	±0.1
Bandwidth/ $BW(\pm 1dB)$	200kHz	200kHz	200kHz	200kHz
Bandwidth/ $BW(\pm 3dB)$	300kHz	300kHz	300kHz	300kHz
Response time/ $t_r$	0.3µs	0.3µs	0.3µs	0.3µs
Maximum zero error voltage/ $V_{0E}$	±5.3mV	±2.21mV	±1.35mV	±0.725mV
Supply voltage/ $V_c$	+5V	+5V	+5V	+5V
Operating temperature/ $T_A$	-40°C~80°C	-40°C~80°C	-40°C~80°C	-40°C~80°C
Installation method	Direct welding	Direct welding	Direct welding	Direct welding
Weight	9g	9g	9g	9g



# TYPICAL APPLICATIONS

CAFR series

## © Rail transit

Preventive maintenance of major locomotive equipment (switch machine, PSD, signal system rail, etc.) is critical to reducing the disruption of locomotive service caused by equipment failure and lowering life cycle costs. Online monitoring allows for key preventive actions before any abnormalities that cause defects occur.

Sensors, for example, can monitor the motor current of a switch machine. The current deviation from the normal range indicates that equipment may fail and that preventive maintenance is required. Timely scheduled maintenance can avert track interruptions, saving significant costs.

Typical trackside applications include: track target monitoring/switch machine/track circuit/screen door/substation (circuit breaker of transformer...)

## © Driver

Current sensors are used in elevators, forklifts, machine tools, robots, and all equipment using industrial motor drives to achieve efficient control, regulation, energy conservation, and comfort functions. Driver control requires dependable and accurate current measurement to enable engineers to create systems with isolated current measurements directly on the motor phase.

The sensors are used to measure constantly changing currents for feedback purposes. This results in precise modifications to the equipment operation. For machine tools, when the tool starts working on the parts to be processed, the current quickly increases. The better and faster the feedback signal, the smoother device information control.







# INTRODUCTION TO VOLTAGE SENSOR

Hangzhi's high-precision voltage sensor is a fluxgate-based voltage measurement and control component that precisely measures DC, AC, pulse, and various irregular voltages under perfect primary and secondary isolation. It is one of the most accurate voltage sensors in the industrial area. The fundamental principle is as follows: Connect the positive and negative poles of the high-voltage DC source in series with a megaohm level resistor to limit the current to the microampere level; the microampere current is indirectly accurately detected by using magnetic modulation technology to

detect the magnetic field generated by microampere current accurately, and then the voltage of the high-voltage DC source is accurately calculated based on Ohm's law. It is primarily utilized in metrological verification and calibration applications requiring high accuracy, rail transit, power quality analysis, power analyzers, medical equipment, aerospace, naval vessels, and other applications requiring high sensitivity, stability, and reliability.



## High precision

0.1% measurement accuracy, 0.05% linearity, and 0.02% customized product accuracy.



## High reliability

the primary and secondary insulation withstand voltages beyond 10KV, with low-temperature drift, low zero drift, high and low-temperature resistance, and a working temperature range of -40-85 ° C.

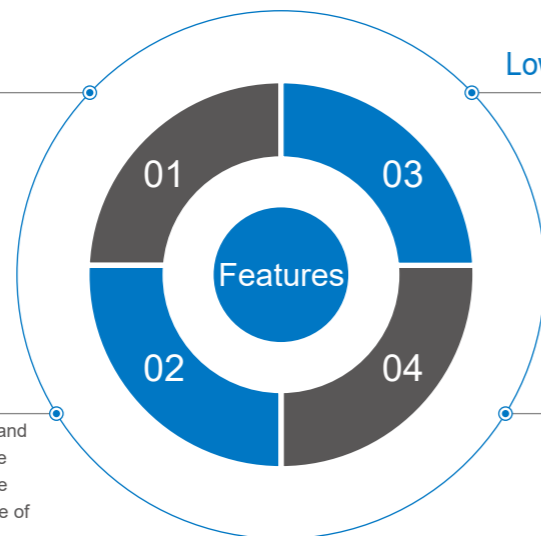

## Low primary power consumption

The primary current is less than 1mA, and for customized models, it is as low as 0.1mA, and the primary power consumption is low.



## Customizable

Power supply voltage, signal output voltage, primary and secondary insulation strength, and primary current limiting resistance can all be modified to meet the customer's needs.

High-precision voltage sensor

# HCV SERIES

HCV50~HCV1000

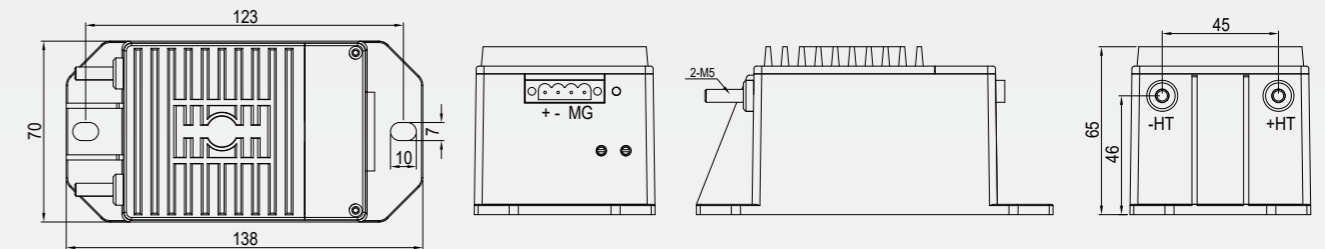

Product model	HCV50	HCV200	HCV500	HCV1000
Primary RMS voltage/ $V_{PN}$	35V	140V	350V	707V
Measurement voltage/ $V_{PM}$	$\pm 50V$	$\pm 200V$	$\pm 500V$	$\pm 1000V$
Working voltage/ $V_c$	15V	15V	15V	15V
Power consumption/ $I_c$	130+VS/RL	130+VS/RL	130+VS/RL	130+VS/RL
Transformation ratio (input: output)/ $K_N$	50: 10	200: 10	500: 10	1000: 10
Secondary rated output voltage/ $V_s$	$\pm 10V$	$\pm 10V$	$\pm 10V$	$\pm 10V$
Secondary output internal current limiting resistor/ $R_{Lm}$	100 $\Omega$	100 $\Omega$	100 $\Omega$	100 $\Omega$
Secondary output load/ $R_L$	>2k $\Omega$	>2k $\Omega$	>2k $\Omega$	>2k $\Omega$
Accuracy/ $X_s$	0.2%	0.2%	0.2%	0.2%
Linearity/ $\epsilon_L$	0.05%	0.05%	0.05%	0.05%
Zero offset voltage/ $V_o$	$\pm 5mV$	$\pm 5mV$	$\pm 5mV$	$\pm 5mV$
Response time/ $t_r$	$\pm 10\mu s$	$\pm 10\mu s$	$\pm 10\mu s$	$\pm 10\mu s$
Bandwidth/BW(3dB)	300kHz	300kHz	300kHz	300kHz
Operating temperature/ $T_A$	-40°C~75°C	-40°C~75°C	-40°C~75°C	-40°C~75°C
Installation method	Screws	Screws	Screws	Screws
Weight	610 $\pm 5g$	610 $\pm 5g$	610 $\pm 5g$	610 $\pm 5g$

# High-precision voltage sensor

# HCV SERIES

## HCV1500~HCV3000

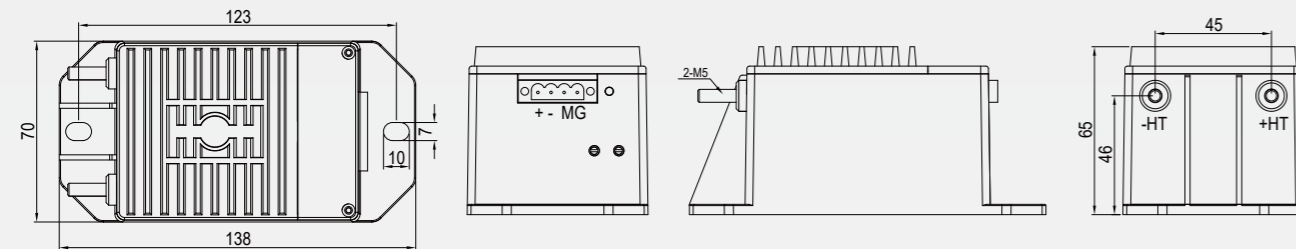

Product model	HCV1500	HCV2000	HCV3000
Primary RMS voltage/ $V_{PM}$	1050V	1400V	2100V
Measurement voltage/ $V_{PM}$	$\pm 1500V$	$\pm 2000V$	$\pm 3000V$
Working voltage/ $V_c$	15V	15V	15V
Power consumption/ $I_c$	130+VS/RL	130+VS/RL	130+VS/RL
Transformation ratio (input: output)/ $K_N$	1500: 10	2000: 10	3000: 10
Secondary rated output voltage/ $V_s$	$\pm 10V$	$\pm 10V$	$\pm 10V$
Secondary output internal current limiting resistor/ $R_{Lm}$	100 $\Omega$	100 $\Omega$	100 $\Omega$
Secondary output load/ $R_L$	>2k $\Omega$	>2k $\Omega$	>2k $\Omega$
Accuracy/ $X_s$	0.2%	0.2%	0.2%
Linearity/ $\epsilon_L$	0.05%	0.05%	0.05%
Zero offset voltage/ $V_o$	$\pm 5mV$	$\pm 5mV$	$\pm 5mV$
Response time/ $t_r$	$\pm 10\mu s$	$\pm 10\mu s$	$\pm 10\mu s$
Bandwidth/BW(3dB)	300kHz	300kHz	300kHz
Operating temperature/ $T_A$	-40°C~75°C	-40°C~75°C	-40°C~75°C
Installation method	Screws	Screws	Screws
Weight	610 $\pm 5g$	610 $\pm 5g$	610 $\pm 5g$

# TYPICAL APPLICATIONS

## HCV Series

### Motor voltage test of new energy vehicles

The motor, which is the heart of electric vehicles, is the vehicle's power source. As a result, motor testing is particularly important. In addition, the DC voltage stabilization system must stabilize the voltage within a specific range at both ends of the battery at a stable DC bus voltage for direct application or other voltage conversions.

Additionally, the mass load power supply system converts the stable high-voltage power output from the DC bus of the electric vehicle's battery into low-voltage output, supplying power to the vehicle's low-voltage DC load.

Hangzhi high-precision voltage sensors can handle low voltage measuring requirements.

### Power system protection device

The power system protection device continuously monitors the operation of the power grid and detects voltage and current. The Hangzhi high-precision voltage sensor is highly stable and can meet the voltage detection requirements of the power grid.

### Other applications

The core converters of urban transportation systems (subway - tramcar - trolleybus), track locomotive monitoring, subway stations, inverters, converters, rectifiers, etc.



# HIGH-PRECISION TEST INSTRUMENT

## HIU Series High-precision AC/DC Tester

# HIU SERIES

## HIU600B~HIU1000L

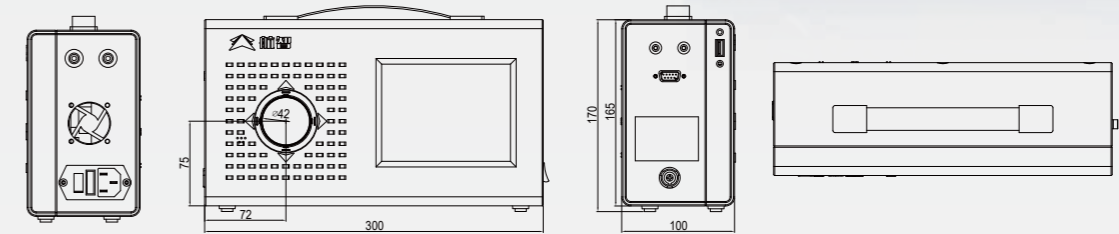

High-precision electrical measuring instruments are a new generation of intelligent high-tech electrical energy measurement instruments developed and manufactured by Hangzhi. It employs a completely new software and hardware design that can measure single AC and DC voltage, current, frequency, phase, active power, active energy, and so on, as well as high harmonic distortion (up to 63 harmonics).

It is widely used in battery charging and discharging equipment manufacturers and battery manufacturers for finished product detection, measurement, and automatic calibration of battery charging and discharging equipment, AC and DC measurement in measurement research institutes, power, measurement, military industry, manufacturing, scientific research, and other fields, government inspection agencies and other measurement fields for single AC and DC voltmeters, ammeters, and power meters.



### Portable

small and lightweight, easy to carry for on-site testing and calibration.



### AC/DC UNIVERSAL

it can detect DC, AC, DC voltage, AC voltage, DC power, AC power harmonics, electrical energy, and count.

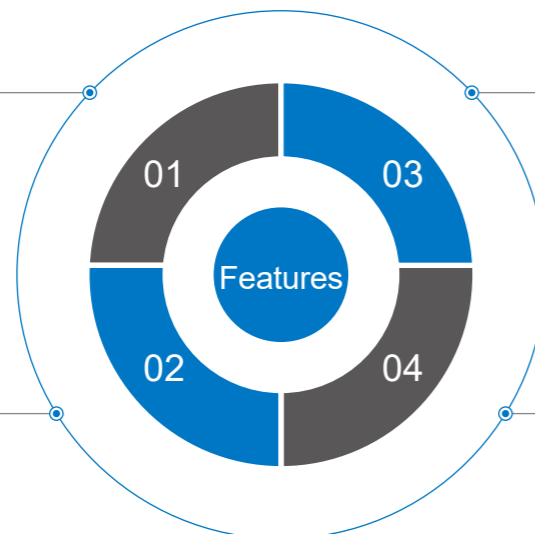

### Real-time communication

it has a communication interface and can transmit detection data to the upper computer



### High precision

automatic switching of multi-level ranges, precise amplification of microvolt level weak signals, and one-thousandth of rated range accuracy.

Product model	HIU600B	HIU1000B	HIU600L	HIU1000L	
DC current	Measurement range limit	600A	1000A	600A	1000A
	Measurement range	(0~110%)RG	(0~110%)RG	(0~110%)RG	(0~110%)RG
	Measurement accuracy	±0.02%RD(20A≤I≤600A)	±0.02%RD(30A≤I≤1000A)	±0.05%RD(500mA≤I≤600A)	±0.05%RD(1A≤I≤1000A)
	Measurement resolution	0.002%RD(20A≤I≤600A)	0.002%RD(30A≤I≤1000A)	0.005%RD(500mA≤I≤600A)	0.005%RD(1A≤I≤1000A)
DC voltage	Measurement range limit	1000V	1000V	1000V	1000V
	Measurement range	(0~110%)RG	(0~110%)RG	(0~110%)RG	(0~110%)RG
	Measurement accuracy	±0.02%RD(20V≤U≤1000V)	±0.02%RD(20V≤U≤1000V)	±0.05%RD(20V≤U≤1000V)	±0.05%RD(20V≤U≤1000V)
AC current	Measurement range limit	424A	707A	424A	707A
	Measurement range	(0~110%)RG	(0~110%)RG	(0~110%)RG	(0~110%)RG
	Measurement accuracy	±0.05%RD(15A≤I≤424A)	±0.05%RD(20A≤I≤707A)	±0.05%RD(500mA≤I≤424A)	±0.05%RD(1A≤I≤707A)
AC voltage	Measurement range limit	707V	707V	707V	707V
	Measurement range	(0~110%)RG	(0~110%)RG	(0~110%)RG	(0~110%)RG
	Measurement accuracy	±0.05%RD(30V≤U≤707V)	±0.05%RD(30V≤U≤707V)	±0.05%RD(30V≤U≤707V)	±0.05%RD(30V≤U≤707V)
DC power	Measurement accuracy	±0.02%RD (20V≤U≤1000V, 20A≤I≤600A)	±0.02%RD (20V≤U≤1000V, 30A≤I≤1000A)	±0.05%RD (20V≤U≤1000V, 500mA≤I≤600A)	±0.05%RD (20V≤U≤1000V, 1A≤I≤1000A)
	AC active power	Measurement accuracy	±0.05%RD (30V≤U≤707V, 15A≤I≤424A)	±0.05%RD (30V≤U≤707V, 1A≤I≤707A)	±0.05%RD (30V≤U≤707V, 500mA≤I≤424A)
Other Indexes	Voltage range of work power supply	AC85V ~ 265V, 50/60Hz	AC85V ~ 265V, 50/60Hz	AC85V ~ 265V, 50/60Hz	AC85V ~ 265V, 50/60Hz
	Operating temperature	10~35°C	10~35°C	10~35°C	10~35°C
	Relative humidity	≤85%, no corrosive gas	≤85%, no corrosive gas	≤85%, no corrosive gas	≤85%, no corrosive gas
	Size	about 300mm×185mm×100mm (length * width * height) (excluding bulge)	about 300mm×185mm×100mm (length * width * height) (excluding bulge)	about 300mm×185mm×100mm (length * width * height) (excluding bulge)	about 300mm×185mm×100mm (length * width * height) (excluding bulge)
Weight	3.0kg	3.0kg	3.0kg	3.0kg	

PSM Series Portable AC/DC Standard Meter

# PSM SERIES

PSM600~PSM1500

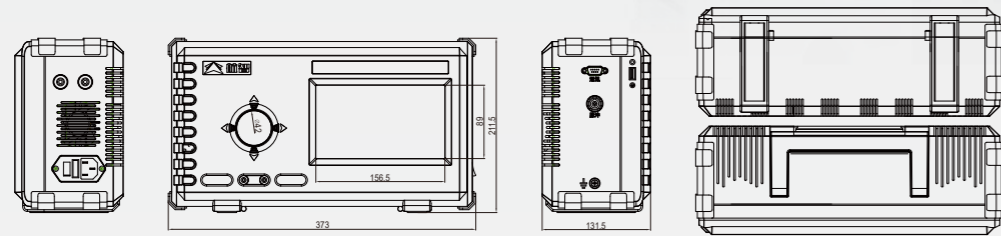

Product model	PSM600	PSM1000	PSM1500	
DC current	Measurement range limit	600A	1000A	1500A
	Measurement range	(0~110%)RG	(0~110%)RG	(0~110%)RG
	Measurement accuracy	±0.02%RD(500mA≤I≤600A)	±0.02%RD(1A≤I≤1000A)	±0.02%RD(75A≤I≤1500A)
DC voltage	Measurement range limit	1000V	1000V	1000V
	Measurement range	(0~110%)RG	(0~110%)RG	(0~110%)RG
	Measurement accuracy	±0.02%RD(20V≤U≤1000V)	±0.02%RD(20V≤U≤1000V)	±0.02%RD(20V≤U≤1000V)
AC current	Measurement range limit	424A	707A	1000A
	Measurement range	(0~110%)RG	(0~110%)RG	(0~110%)RG
	Measurement accuracy	±0.05%RD(500mA≤I≤424A)	±0.05%RD(1A≤I≤707A)	±0.05%RD(50A≤I≤1000A)
AC voltage	Measurement range limit	707V	707V	707V
	Measurement range	(0~110%)RG	(0~110%)RG	(0~110%)RG
	Measurement accuracy	±0.05%RD(30V≤U≤707V)	±0.05%RD(30V≤U≤707V)	±0.05%RD(30V≤U≤707V)
DC power	Measurement accuracy	±0.02%RD (20V≤U≤1000V, 500mA≤I≤600A)	±0.02%RD (20V≤U≤1000V, 1A≤I≤1000A)	±0.02%RD (20V≤U≤1000V, 75A≤I≤1500A)
	Measurement accuracy	±0.05%RD (30V≤U≤707V, 500mA≤I≤424A)	±0.05%RD (30V≤U≤707V, 1A≤I≤707A)	±0.05%RD (30V≤U≤707V, 50A≤I≤1000A)
Other Indexes	Voltage range of work power supply	AC85V ~ 265V, 50/60Hz	AC85V ~ 265V, 50/60Hz	AC85V ~ 265V, 50/60Hz
	Operating temperature	10~35°C	10~35°C	10~35°C
	Relative humidity	≤85%, no corrosive gas	≤85%, no corrosive gas	≤85%, no corrosive gas
	Size	about 373mm×211.5mm×131.5mm (length * width * height) (excluding bulge)	about 373mm×211.5mm×131.5mm (length * width * height) (excluding bulge)	about 373mm×211.5mm×131.5mm (length * width * height) (excluding bulge)
Weight	5.5kg	5.5kg	5.5kg	

0.01% Grade High-precision DC Tester

# PIU SERIES

PIU600~PIU1500

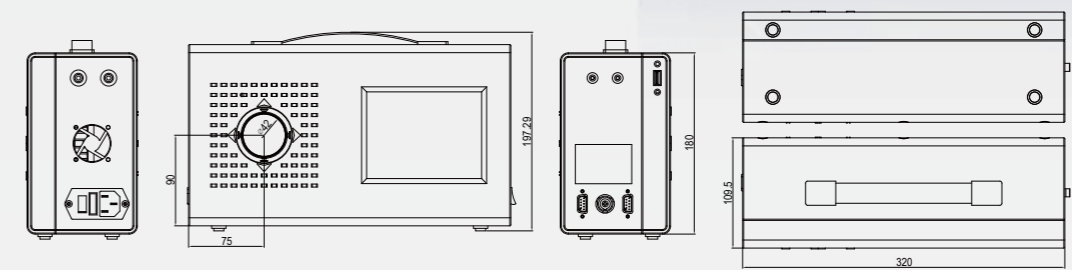

Product model	PIU600	PIU1000	PIU1500	
DC current	Measurement range limit	600A	1000A	1500A
	Measurement range	(0~110%)RG	(0~110%)RG	(0~110%)RG
	Measurement accuracy	±0.01%RD(30A≤I≤600A)	±0.01%RD(50A≤I≤1000A)	±0.01%RD(75A≤I≤1500A)
DC voltage	Measurement range limit	1000V	1000V	1000V
	Measurement range	(0~110%)RG	(0~110%)RG	(0~110%)RG
	Measurement accuracy	±0.01%RD(50V≤U≤1000V)	±0.01%RD(50V≤U≤1000V)	±0.01%RD(50V≤U≤1000V)
DC power	Measurement accuracy	±0.01%RD (50V≤U≤1000V, 30A≤I≤600A)	±0.01%RD (50V≤U≤1000V, 50A≤I≤1000A)	±0.01%RD (50V≤U≤1000V, 75A≤I≤1500A)
	Measurement accuracy	±0.01%RD (30V≤U≤707V, 500mA≤I≤424A)	±0.01%RD (30V≤U≤707V, 1A≤I≤707A)	±0.01%RD (30V≤U≤707V, 50A≤I≤1000A)
Other Parameters	Work power supply voltage	AC85V ~ 265V, 50/60Hz	AC85V ~ 265V, 50/60Hz	AC85V ~ 265V, 50/60Hz
	Preheat time	≤30 minutes	≤30 minutes	≤30 minutes
	Operating temperature	10°C ~ 35°C	10°C ~ 35°C	10°C ~ 35°C
	Relative humidity	≤85%, no corrosive gas	≤85%, no corrosive gas	≤85%, no corrosive gas
Size	Size	320mm*180mm*110mm (length * width * height) (excluding bulge)	320mm*180mm*110mm (length * width * height) (excluding bulge)	320mm*180mm*110mm (length * width * height) (excluding bulge)
	Weight	3.0kg	3.0kg	3.0kg

0.01% Grade High-precision DC Tester

# PIU SERIES

PIU2000~PIU10000

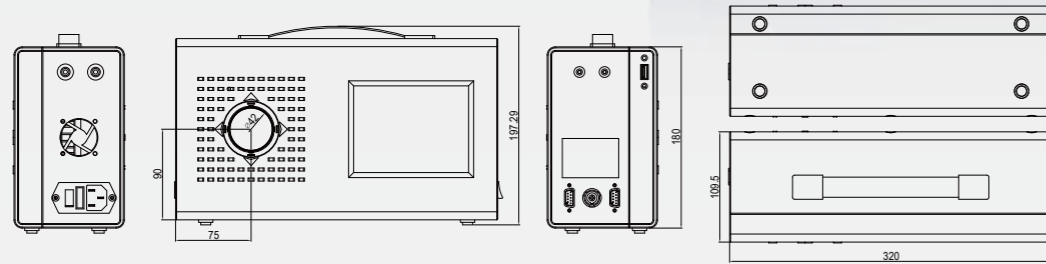

Product model	PIU2000	PIU5000	PIU10000	
DC current	Measurement range limit	2000A	5000A	10000A
	Measurement range	(0~110%)RG	(0~110%)RG	(0~110%)RG
	Measurement accuracy	±0.01%RD(100A≤I≤2000A)	±0.01%RD(250A≤I≤5000A)	±0.01%RD(500A≤I≤10000A)
	Measurement resolution	0.001%RD(100A≤I≤2000A)	0.001%RD(250A≤I≤5000A)	0.001%RD(500A≤I≤10000A)
DC voltage	Measurement range limit	1000V	1000V	1000V
	Measurement range	(0~110%)RG	(0~110%)RG	(0~110%)RG
	Measurement accuracy	±0.01%RD(50V≤U≤1000V)	±0.01%RD(50V≤U≤1000V)	±0.01%RD(50V≤U≤1000V)
	Measurement resolution	0.001%RD(50V≤U≤1000V)	0.001%RD(50V≤U≤1000V)	0.001%RD(50V≤U≤1000V)
DC power	Measurement accuracy	±0.01%RD (50V≤U≤1000V, 100A≤I≤2000A)	±0.01%RD (50V≤U≤1000V, 250A≤I≤5000A)	±0.01%RD (50V≤U≤1000V, 500A≤I≤10000A)
	Work power supply voltage	AC85V ~ 265V, 50/60Hz	AC85V ~ 265V, 50/60Hz	AC85V ~ 265V, 50/60Hz
Other Parameters	Preheat time	≤30 minutes	≤30 minutes	≤30 minutes
	Operating temperature	10°C ~ 35°C	10°C ~ 35°C	10°C ~ 35°C
	Relative humidity	≤85%, no corrosive gas	≤85%, no corrosive gas	≤85%, no corrosive gas
	Size	320mm*180mm*110mm (length * width * height) (excluding bulge)	320mm*180mm*110mm (length * width * height) (excluding bulge)	320mm*180mm*110mm (length * width * height) (excluding bulge)
	Weight	/	/	/



# TYPICAL APPLICATIONS

PIU Series

## Application Overview

The battery charging and discharging testing system mainly consists of a microcomputer control unit, a charging unit (DC stable power supply), a discharging unit (DC electronic load), a charging/discharging switching unit, a measuring unit, etc.

The battery charging and discharging testing system is a device that regulates and protects battery charging and discharging by establishing charging and discharging parameters. The typical voltage range can be regulated throughout the battery charging and discharging operation to prevent overcharging or discharging of the battery. The typical current range can be set. When the test reaches the specified value, it will immediately terminate. The battery charging and discharging testing system is primarily used to detect the battery's current, voltage, capacity, internal resistance, charging and discharging temperature, battery cycle life, etc. There are many channels to choose from and different battery models and types can be tested at the same time.

## The parameters of the battery charging and discharging testing system that must be measured

- Voltage range: 100mV~1000V, maximum allowable error: ± (0.02% -5%);
- Voltage measurement range: 100mV~1000V, maximum allowable error: ± (0.02% -5%);
- Setting range of charging and discharging current: 10mA~1500A, maximum allowable error: ± (0.05% -5%);
- The charging and discharging current measurement range is 10mA~1500A, with maximum allowable error: ± (0.05% -5%).



## PIU series high-precision DC tester parameters

- Voltage measurement range: ± (0.1V -1000V), maximum allowable error: ± 0.005%;
- Current measurement range: 10mA~2000A, maximum allowable error: ± 0.005%

The above parameters demonstrate that the accuracy of the PIU series high-precision DC tester is at least two orders of magnitude greater than the parameters required by the battery charging and discharging testing system for metrological verification, fully meeting the needs of the battery charging and discharging testing system for metrological verification.